

Motorsport and racing connectors
Souriau 8STA, 8TA and microComp® series

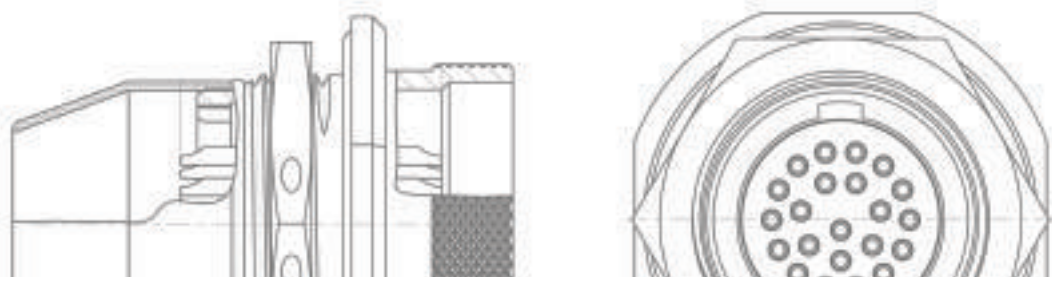



8STA, 8TA and microComp[®] series connectors

Typical applications



Engine



Data acquisition system



Steering wheel

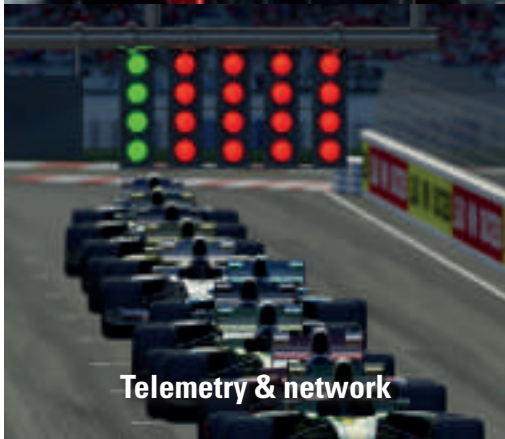

Telemetry & network



Fuel tank



e-racing

Micro-miniature connectors with innovative quick-mating

The Souriau 8STA is ideal for motorsport applications with extreme space and weight constraints. Our high-performance connectors can be found on cars and motorcycles throughout the world of competitive motorsport—primarily for sensors and electric systems.

Reliability in harsh environments

The 8STA, 8TA and microComp series of miniature connectors incorporate high-reliability features to ensure driver safety and correct vehicle operation. Derived from international military specifications MIL-DTL-38999 and JN1003, our lightweight yet rugged connectors can withstand high levels of shock and vibration.

Optimized for winning performance

We offer more than 100 derived versions of our motorsport connector series and we're continually expanding and enhancing our products to meet the market's complete interconnect needs. We also have the capabilities to produce derived products on demand, and our worldwide distributor network maintains high levels of finished connector stock to support fast turnarounds for customer orders.



Souriau 8STA, 8TA and microComp® series

Motorsport solutions 5

8STA/8TA series 6



Contact layouts	6
8STA series	12
Ultra miniature shell size 01	12
Shell sizes 08 to 24	17
Power contacts	21
High density	24
Integrated clinch nuts	26
Single hole fixing	28
Quick release for steering boss system	30
Blind mating plug	32
Hermetic connectors	34
Hermetic feedthrough	38
PC tail contacts	40
8STA/8TA series - Fuel immersible	43
8TA series - Compact low profile	45
Contacts	48
Contacts, wiring instructions	49
Filler plugs, crimping tools	50
Insertion and extraction tools, boots, shrinkable termination detail	51
Metal protective caps	52
Nut plates, gaskets	53

microComp® series 54

Technical specifications	54
Ordering information	55



From standard to specific solutions for motorsport

The motorsport market is driven by innovations, and we're dedicated to meet your needs. We have the capability to produce derived products on demand to help you take the lead. One of our primary objectives is to push the boundaries in terms of miniaturization and weight reduction, demonstrated by the introduction of the 8STA shell size 01, the world's smallest motorsport connector with removable contacts.

8STA series	8TA series	microComp®
Miniature sizes 02, 04, 06 Up to shell size 24	Compact low profile	Crimp removable contacts AWG 24 to 28
Scoop proof	Conductive black zinc or nickel plating	High density layouts from 7 to 104 ways
Conductive black zinc or nickel plating	Color-coded keyway	High vibration and shock withstanding
Color-coded keyway		Non magnetic

Reliable and customized solutions

Based on standard series:

- 8STA & 8TA series
- microComp® series



Lightweight
High density layouts, miniature sizes, integrated backshell, composite shell.



Power distribution
High voltage.
High current.



Custom solutions
Innovative solutions. Let your need take the lead.



Fuel pump
Fuel, oils and lubricant immersion.
Extremely reliable in continuous immersion.



Engine control unit
High power load, critical function.
Extremely reliable in harsh environments.



Sensors
Extreme vibration.
Restricted areas.



Quick release
Frequent disconnect.
Difficult areas to reach.

8STA/8TA series

Contact layouts

Contact layouts

S Signal P Power C Concentric Twinax (=Triax) or Coax HD High Density H Hermetic version developed F Fuel Immersible version developed

Contact sizes #26 #22D #20 #16 #12 #8 Coax or Concentric Twinax - consult us #8 Power #4 Power

01

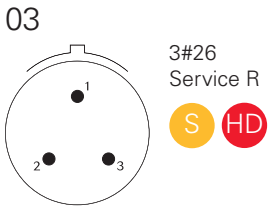

02

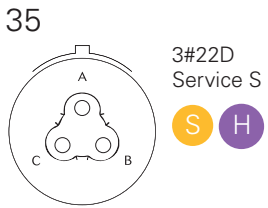
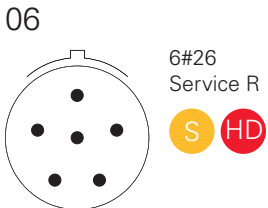
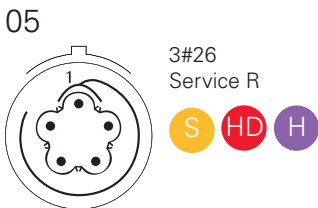
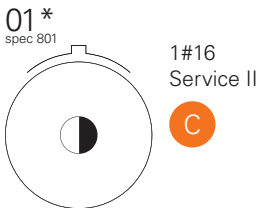

* Consult us

04

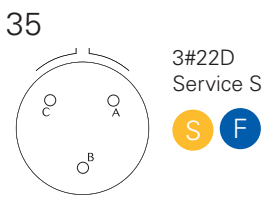
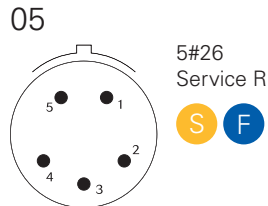

06

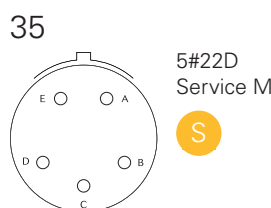
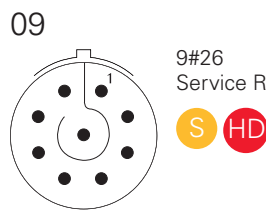
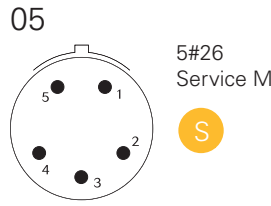

08

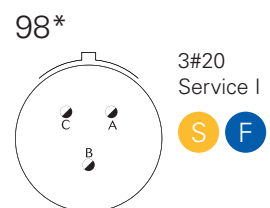
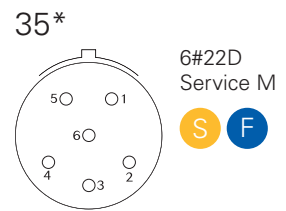
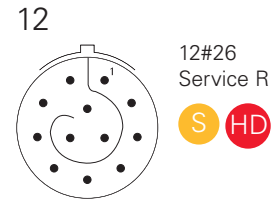

* Available for 8TA Series

Sizes 01 and 02: Marking on shell.

Rear view of receptacle for male and female insulator. Opposite marking between plug and receptacle.

Sizes 04 to 24: Marking on insulator.

Front view of male insulator for plug and receptacle. Opposite marking between male and female insulator.

Contact layouts

● Signal ● Power ● Concentric Twinax (=Triax) or Coax ● HD High Density ● H Hermetic version developed ● F Fuel Immersible version developed

Contact sizes #26 #22D #20 #16 #12 #8 Coax or Concentric Twinax - consult us #8 Power #4 Power

10

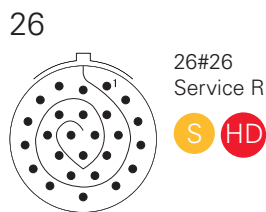
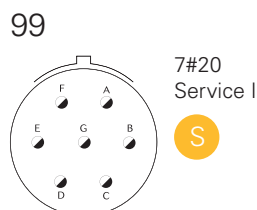
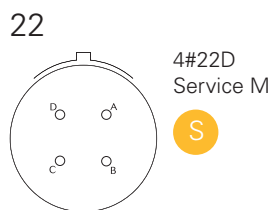
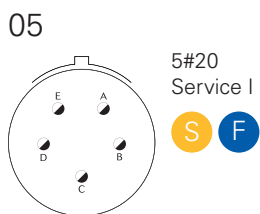
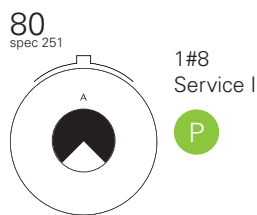
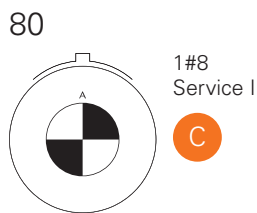
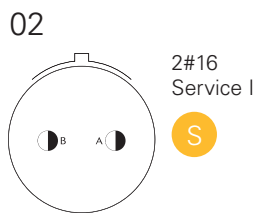
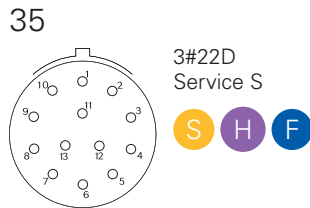
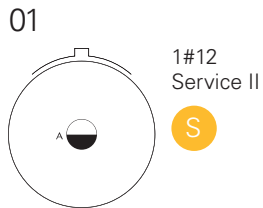

12

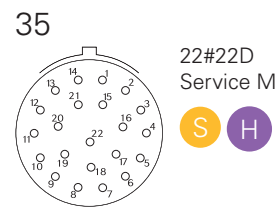
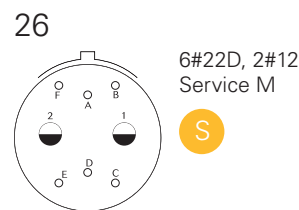
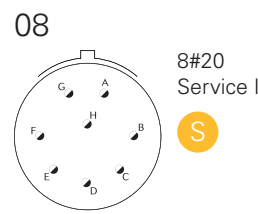
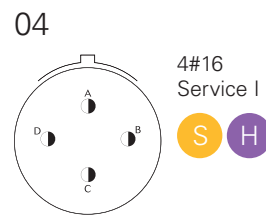
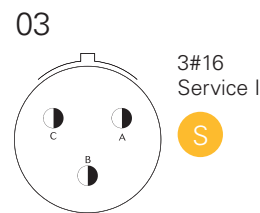
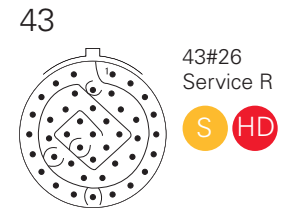
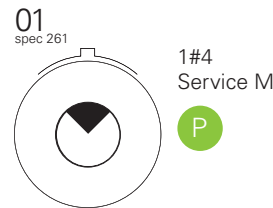

Sizes 01 and 02: Marking on shell.

Rear view of receptacle for male and female insulator. Opposite marking between plug and receptacle.

Sizes 04 to 24: Marking on insulator.

Front view of male insulator for plug and receptacle. Opposite marking between male and female insulator.

8STA/8TA series

Contact layouts

Contact layouts

S Signal P Power C Concentric Twinax (=Triax) or Coax HD High Density H Hermetic version developed F Fuel Immersible version developed

Contact sizes #26 #22D #20 #16 #12 #8 Coax or Concentric Twinax - consult us #8 Power #4 Power

14

05

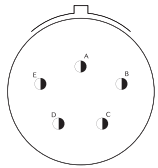

5#16
Service II



35

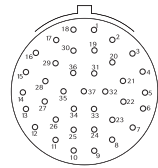

37#22D
Service M



15

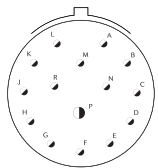

14#20, 1#16
Service I



68

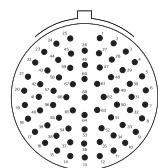

68#26
Service R



18

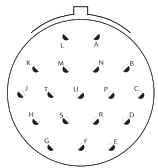

18#20
Service I



97

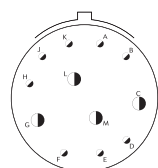

8#20, 4#16
Service I



19

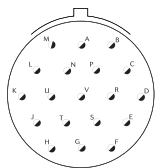

19#20
Service I



Contact layouts

S Signal P Power C Concentric Twinax (=Triax) or Coax HD High Density H Hermetic version developed F Fuel Immersible version developed

Contact sizes ● #26 ○ #22D ◐ #20 ◑ #16 ◒ #12 ◓ #8 Coax or Concentric Twinax - consult us ◔ #8 Power ◕ #4 Power

16

02

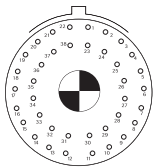

38#22D, 1#8
Service M



22
spec 251

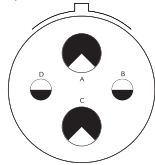

2#12, 2#8
Service M



18

11

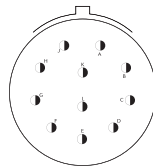

11#16
Service II



02

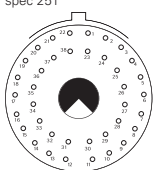

38#22D, 1#8
Service N



26

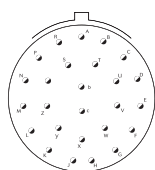

26#20
Service I



18

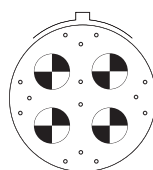

14#22D, 4#8
Service M



06

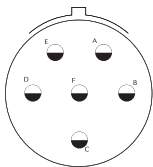

6#12
Service I



35

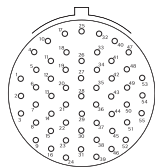

55#22D
Service M



18
spec 251

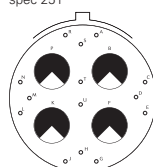

14#22D, 4#8
Service M



08

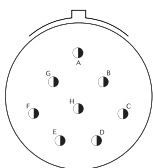

8#16
Service II



75

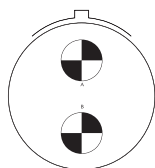

2#8
Service M



28

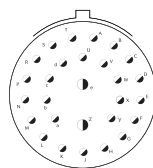

26#20, 2#16
Service I



20

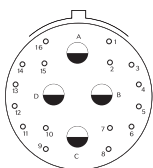

16#22D, 4#12
Service II



75
spec 251

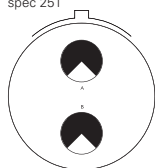

2#8
Service M



32

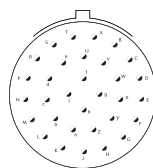

32#20
Service I



22

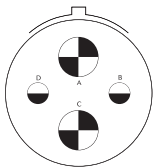

2#12, 2#8
Service M



99

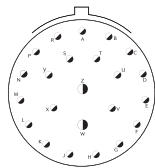

2#16, 21#20
Service I



35

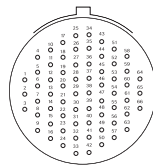

66#22D
Service M



Sizes 04 to 24: Marking on insulator.

Front view of male insulator for plug and receptacle. Opposite marking between male and female insulator.

8STA/8TA series

Contact layouts

Contact layouts

S Signal P Power C Concentric Twinax (=Triax) or Coax HD High Density H Hermetic version developed F Fuel Immersible version developed

Contact sizes ● #26 ○ #22D ◐ #20 ◑ #16 ◒ #12 ◓ #8 Coax or Concentric Twinax - consult us ◔ #8 Power ◕ #4 Power

20

<p>11</p> <p>11#12 Service I</p> <p>S</p>	<p>35</p> <p>79#22D Service M</p> <p>S</p>	<p>48</p> <p>4#8 Service I</p> <p>P</p>	<p>75 spec 251</p> <p>4#8 Service M</p> <p>P</p>
<p>16</p> <p>16#16 Service II</p> <p>S</p>	<p>39</p> <p>37#20, 2#16 Service I</p> <p>S</p>	<p>59</p> <p>55#22D, 4#12 Service M</p> <p>S C</p>	<p>77</p> <p>17#22D, 2#8 Service M</p> <p>S P</p>
<p>20</p> <p>18#20, 2#8 Service M</p> <p>S C</p>	<p>41</p> <p>41#20 Service I</p> <p>S</p>	<p>72</p> <p>6#16, 2#4 Service I</p> <p>S P</p>	<p>77 spec 251</p> <p>17#22D, 2#8 Service M</p> <p>S P</p>
<p>20 spec 251</p> <p>18#20, 2#8 Service M</p> <p>S P</p>	<p>42</p> <p>2#4 Service I</p> <p>P</p>	<p>75</p> <p>4#8 Service M</p> <p>C</p>	

22

<p>06</p> <p>6#8 Service M</p> <p>C</p>	<p>21</p> <p>21#16 Service II</p> <p>S</p>	<p>35</p> <p>100#22D Service M</p> <p>S</p>	<p>54</p> <p>40#22D, 9#16, 4#12 Service M</p> <p>S</p>
<p>06 spec 251</p> <p>6#8 Service M</p> <p>P</p>	<p>32</p> <p>32#20 Service I</p> <p>S</p>	<p>53</p> <p>53#20 Service I</p> <p>S</p>	<p>55</p> <p>55#20 Service I</p> <p>S</p>



Sizes 04 to 24: Marking on insulator.
 Front view of male insulator for plug and receptacle. Opposite marking between male and female insulator.

Contact layouts

S Signal
 P Power
 C Concentric Twinax (=Triax) or Coax

Contact sizes
 #26
 #22D
 #20
 #16
 #12
 #8 Coax or Concentric Twinax - consult us
 #8 Power
 #4 Power

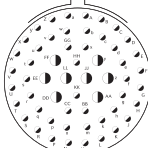
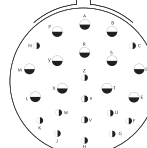
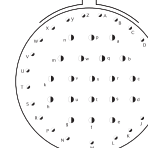
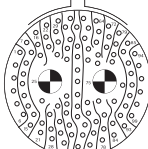
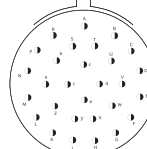
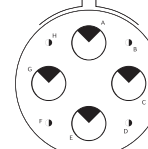
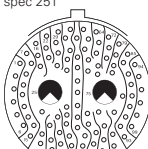
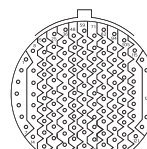
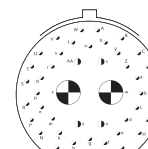
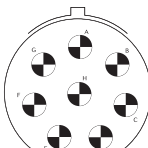
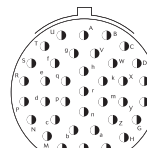
24

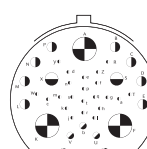
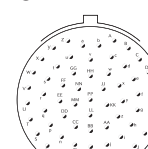
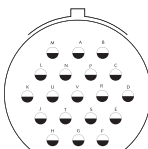
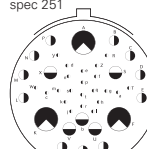
<p>04</p>  <p>48#20, 8#16 Service I</p> <p>S</p>	<p>24</p>  <p>12#16, 12#12 Service II</p> <p>S</p>	<p>43</p>  <p>23#20, 20#16 Service I</p> <p>S</p>
<p>07</p>  <p>97#22D, 2#8 Service M</p> <p>S C</p>	<p>29</p>  <p>29#16 Service I</p> <p>S</p>	<p>44</p>  <p>4#16, 4#4 Service I</p> <p>S P</p>
<p>07 <small>spec 251</small></p>  <p>97#22D, 2#8 Service M</p> <p>S P</p>	<p>35</p>  <p>128#22D Service M</p> <p>S</p>	<p>46</p>  <p>40#20, 4#16, 2#8 Service I</p> <p>S C</p>
<p>08</p>  <p>8#8 Service M</p> <p>C</p>	<p>37</p>  <p>37#16 Service I</p> <p>S</p>	<p>46 <small>spec 251</small></p>  <p>40#20, 4#16, 2#8 Service I</p> <p>S P</p>
<p>08 <small>spec 251</small></p>  <p>8#8 Service M</p> <p>P</p>	<p>41</p>  <p>22#22D, 3#20, 11#16, 2#12, 3#8 Service N</p> <p>S C</p>	<p>61</p>  <p>61#20 Service I</p> <p>S</p>
<p>19</p>  <p>19#12 Service I</p> <p>S</p>	<p>41 <small>spec 251</small></p>  <p>22#22D, 3#20, 11#16, 2#12, 3#8 Service N</p> <p>S P</p>	

Test voltage rating (Vrms)

Service	Sea level	at 21 000 m
R	400	N/A
S	1,000	N/A
M	1,300	800
N	1,000	600
I	1,800	1,000
II	2,300	1,000

Sizes 04 to 24: Marking on insulator.

Front view of male insulator for plug and receptacle. Opposite marking between male and female insulator.

8STA series ultra miniature shell size 01

Technical specifications



Description

- Ultra compact design and very lightweight connector
- Rugged aluminium body to ensure long service life in the harshest environment
- Positive locking mechanism with locked color indicators
- Scoop proof
- 7 color coded keyway orientations
- Boot termination feature
- PCB option available
- Conductive black zinc or nickel plating

Technical specifications

Mechanical

Shell

Aluminium alloy

Shell plating

Conductive black zinc (F)

Insulator

Thermoplastic

Grommet & seal

Liquid silicone rubber

Contact

Copper alloy

Contact plating

Gold

Endurance

500 mating cycles

Shock

Half sine mechanical shock, 50g/11ms

Vibration

147m/s², 10 to 2000Hz

Contact retention

20N Max.

Electrical

Test voltage rating (Vrms)

Service	Sea level
R	400

Contact resistance

<16 mΩ

Insulation resistance

≥ 5000MΩ @ 400Vdc

Contact rating

3 Amp

Environmental

Operating temperature

-55°C to +175°C

Sealing mated connectors

IP67 (1 meter for 30 min minimum)

Salt spray

48 hours

Scale 1:1



Contact layout - Marking on shell

Rear view of receptacle for male and female insulator. Opposite marking between plug and receptacle.

01

03

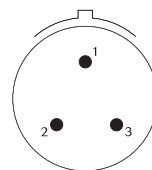

3#26
Service R

Part numbers

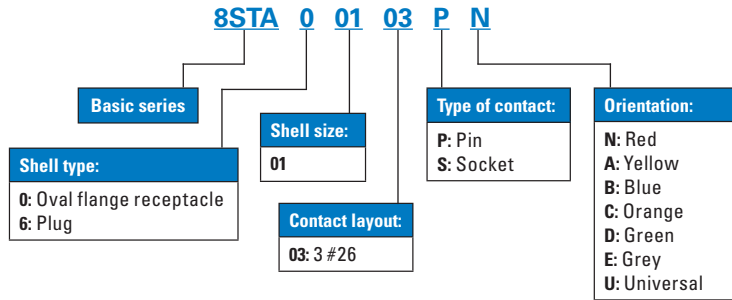

For any other configuration (i.e. clinch nuts, PC tail) please consult us.

Dimensions

Oval flange receptacle

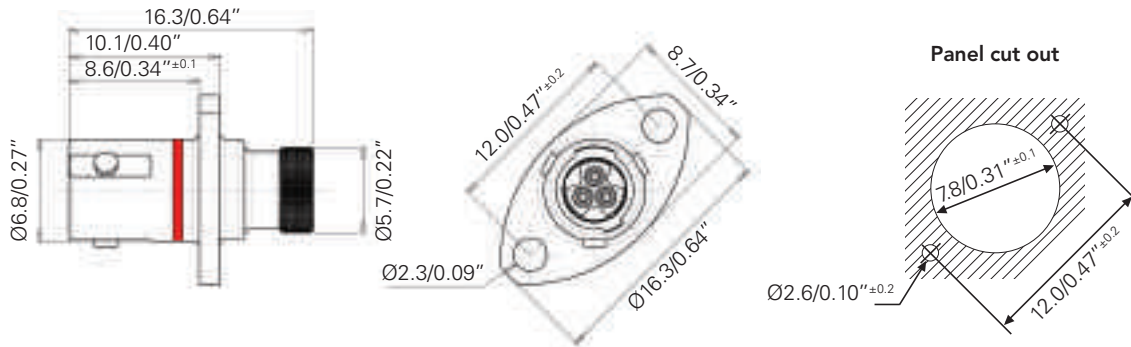

Plug

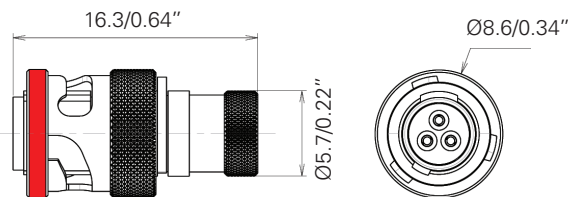

Orientations

Size 1

View from front face of plug

Key positions	Angle A°
N	153°
A	51°
B	102°
C	204°
D	255°
E	306°
U	-

Note: All dimensions are in millimeters and inches (mm/inch).

8STA series miniature shell sizes 02, 04 & 06

Technical specifications



Description

- Ultra compact design & very lightweight connector
- Rugged aluminium body to ensure long service life in the harshest environment
- Positive locking mechanism with locked color indicators
- Scoop proof
- 7 color-coded keyway orientations
- Boot termination feature
- PCB option available
- Conductive black zinc or nickel plating

Technical specifications

Mechanical

Shell

Aluminium alloy
Glass fibre loaded plastic composite (shell size 06 only)

Shell plating

- Aluminum
 - Conductive black zinc
 - Nickel (F)
 - Composite without plating (X)

Insulator

Thermoplastic

Grommet & seal

Liquid silicone rubber

Contact

Copper alloy

Contact plating

Gold

Endurance

500 mating cycles

Shock

300g for 3ms and EIA-364-27

Vibration

147m/s², 10 to 2000Hz

Contact retention

35 N (size 26)
45 N (size 22D)

Electrical

Test voltage

Size 26: 400 Vrms
Size 22D: 1000 Vrms (shell size 02 & 04)
1300 Vrms (shell size 06)

Contact resistance

Size 26: <16 mΩ
Size 22D: <14.6 mΩ

Insulation resistance

≥ 5000MΩ @ 400Vdc / Size 26
≥ 5000MΩ @ 500Vdc / Size 22D

Contact rating

Size 26: 3 Amp
Size 22D: 5 Amp

Environmental

Operating temperature

-55°C to +175°C

Sealing mated connectors

IP67 (1 meter for 30 min minimum)

Salt spray

- Aluminum: 48 hours
- Composite: 500 hours

Part numbers

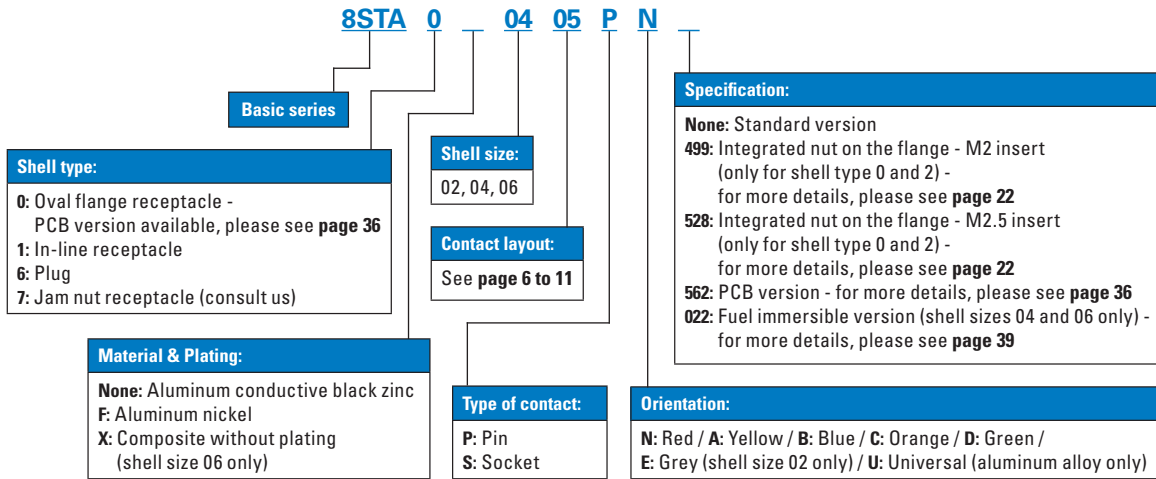

Dimensions

Jam nut receptacle

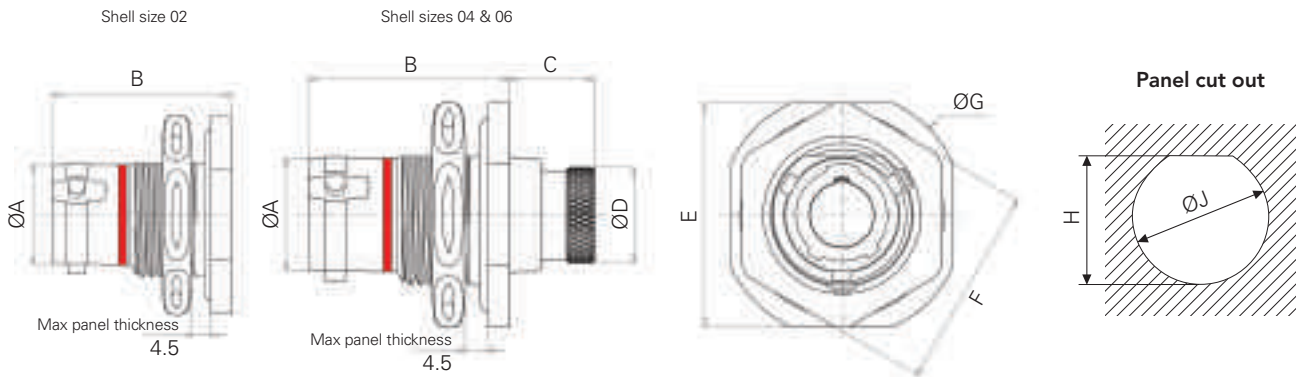

Shell size	ØA Max	B Max	C ^{+0.15}	ØD Max	E Max	F Max	ØG Max	H ^{+0.2}	ØJ ^{+0.1}
02	8.6	16.3 (02-05), 17.6 (02-35)	N/A	N/A	18.2	17	20.5	9.05	9.7
04	10.25	18.3	7.6	8.7	20.2	18.5	22.2	12	12.8
06	11.7	14.25	10.3	10.5	22.25	19.5	24.4	13.7	14.4

Note: All dimensions are in millimeters (mm)

8STA series miniature shell sizes 02, 04 & 06

Ordering information

Oval flange receptacle

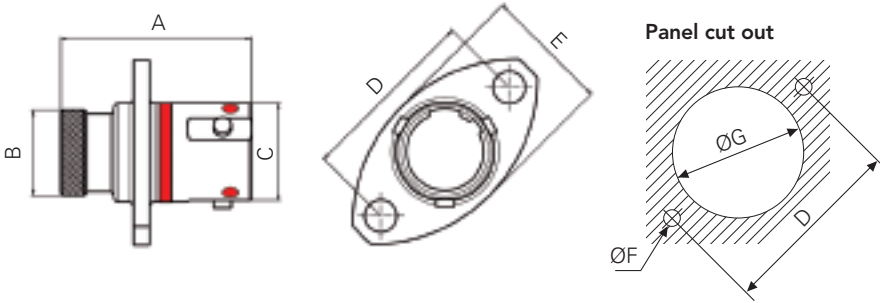

Shell size	A ^{±0.2}	ØB ^{±0.2}	ØC ^{±0.2}	D ^{±0.2}	E Max	ØF ^{±0.2}	ØG ^{±0.1}	Panel tickness (max)	
								Rear mounting	Front mounting
02	17.5	7.2	8.3	15.3	10.7	3.1	9.3	1.5	1.5
02-06	16.7	7.7	8.5	15.3	10.7	3.1	9.3	1.5	1.5
04	18.1	8.5	10.0	16.2	13.2	3.1	12.0	1.0	2.5
06	23.1	10.2	11.55	18.0	14.8	3.1	13.0	1.5	2.5

Plug

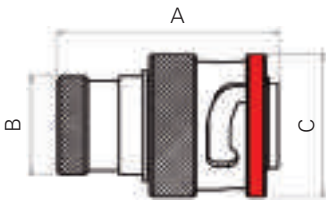

Shell size	A	ØB	ØC
02	17.5	7.2	10.4
02-06	16.7	7.7	10.6
04	18.3 ^{±0.2}	8.5 ^{±0.1}	13.4 ^{±0.1}
06	22.1 ^{±0.1}	10.25 ^{±0.1}	15.05 ^{±0.2}

In-line receptacle

Shell sizes 02 and 04

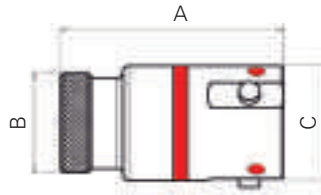

Shell size 06

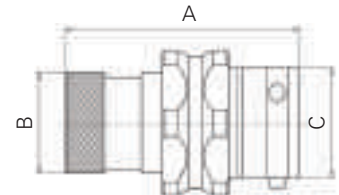

Shell size	A	ØB	ØC
02	17.5	7.2	8.3
02-06	16.7	7.7	10.6
04	18.1 ^{±0.2}	8.5 ^{±0.1}	10.0 ^{±0.2}
06	23.2	10.05	10.8

Orientations

Size 2

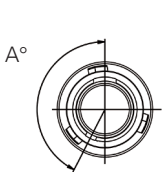

Sizes 4 & 6

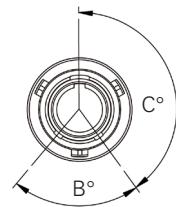

View from front face of plug.

Key positions	N	A	B	C	D	E	U
Angle A°	153°	51°	102°	204°	255°	306°	None
Angle B°	75°	120°	120°	115°	115°	-	None
Angle C°	145°	130°	110°	155°	90°	-	None
Color band	Red	Yellow	Blue	Orange	Green	Grey	None

Note: All dimensions are in millimeters (mm)



Description

- 5 shell styles
- 100% scoop-proof
- EMI-RFI shielding and shell to shell continuity is provided by conductive plating and integral grounding ring fitting to the plug
- Environment sealing from interfacial seal and rear grommet (sealing IP67)
- Positive locking mechanism with locked color indicator
- 6 color-coded keyway orientations
- Conductive black zinc or nickel plating

Technical specifications

Mechanical

Shell

Aluminium alloy

Shell plating

Conductive black zinc
Nickel (F)

Insulator

Thermoplastic

Grommet & seal

Liquid silicone rubber

Contact

Copper alloy

Contact plating

Gold

Endurance

500 mating cycles

Shock

300g for 3ms and EIA-364-27

Vibration

147m/s², 10 to 2000Hz

Contact retention

Size 22D:	45 N
Size 20:	60N
Size 16:	100 N
Size 12:	100 N
Size 8:	110 N
Size 4:	200 N

Electrical

Test voltage

Service	M	N	I	II
Sea level	1,300	1,000	1,800	2,300

Contact resistance

Size 22D:	14.6 mΩ
Size 20:	7.3 mΩ
Size 16:	3.8 mΩ
Size 12:	3.5 mΩ
Size 8:	3 mΩ
Size 4:	2 mΩ

Insulation resistance

≥ 5000 MΩ (at 500 Vdc)

Contact rating

Size 22D:	5 A
Size 20:	7.5 A
Size 16:	13 A
Size 12:	23 A
Size 8:	45 A
Size 4:	80 A

Shell continuity

≤10 mΩ

Environmental

Operating temperature

-55°C to +175°C

Sealing mated connectors

IP67 (1 meter for 30 min minimum)

Salt spray

Aluminum: 48 hours

8STA series shell sizes 08 to 24

Ordering information

Part numbers

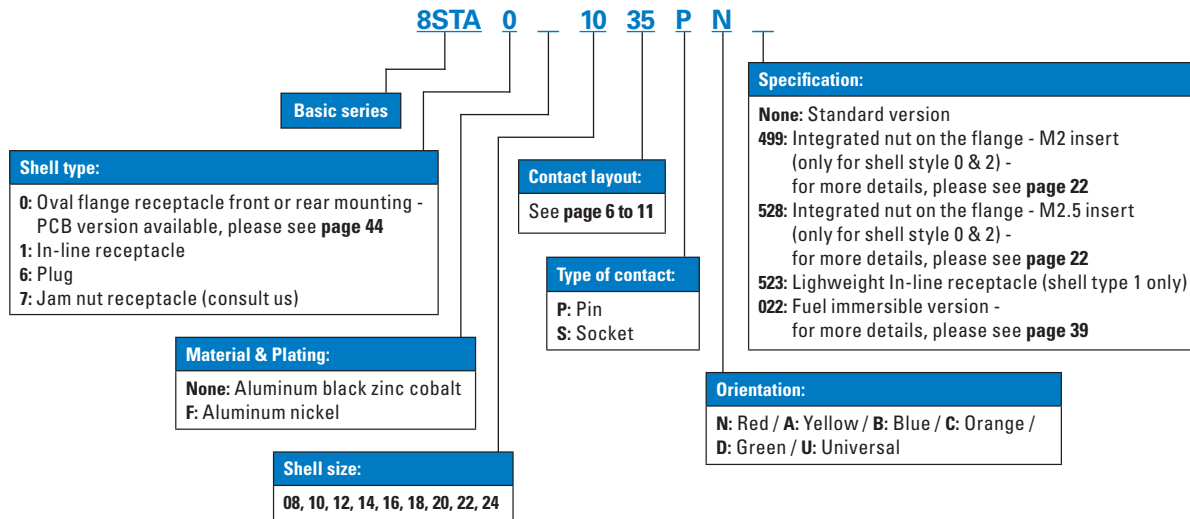

Dimensions

Plug

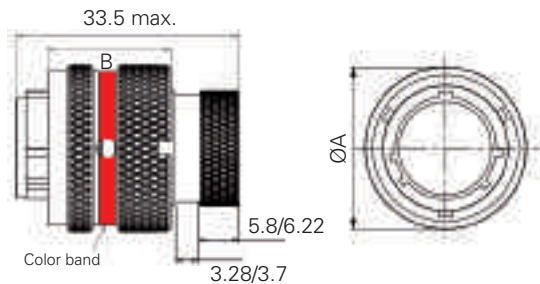

Shell size	ØA max.	B max.
08	18.70	18.55
10	21.50	18.55
12	25.10	18.55
14	29.00	18.55
16	32.20	18.55
18	35.40	18.55
20	38.20	19.30
22	41.30	19.30
24	44.50	19.05

Note: All dimensions are in millimeters (mm)

In-line receptacle

Standard version

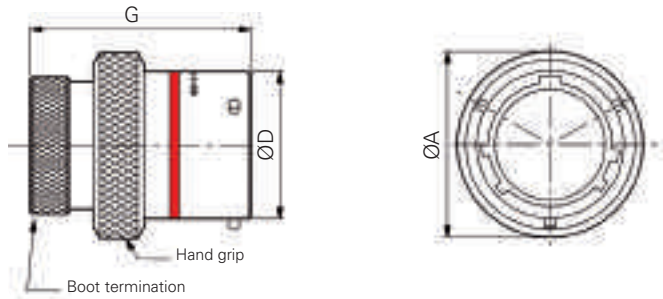

Lightweight version (specification 523)

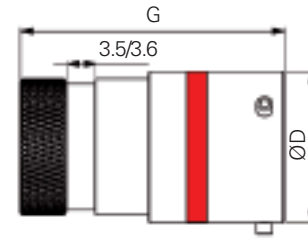

Shell size	8	10	12	14	16	18	20	22	24
ØA max.	17.6	20.7	25.1	28.3	31.4	34.7	38.1	41.2	44.7
ØD ^{+0.20} _{-0.13}	12	15	19.05	22.22	25.4	28.57	31.75	34.92	38.1
G max.	33.5	33.5	33.5	33.5	33.5	33.5	33.5	33.5	33.5

Oval flange receptacle

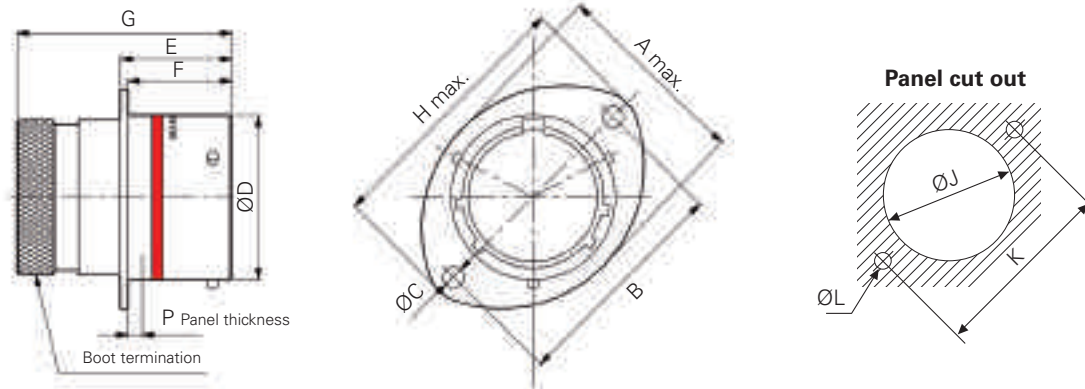

Shell size	A max.	B ^{±0.20}	ØC ⁰ _{-0.1}	ØD ^{+0.2} _{-0.13}	E ⁰ _{+0.15}	F ⁰ _{-0.13}	G max.	H max.	P max.	ØJ ^{±0.10}	K ^{±0.20}	ØL ^{±0.20}
08	16.50	21.40	3.20	12.00	17.21	16.05	33.50	27.20	3.00	14.50	21.40	3.60
10	19.50	25.90	3.20	15.00	17.21	16.05	33.50	32.00	3.00	17.40	25.90	3.60
12	24.00	29.10	3.20	19.05	17.21	16.05	33.50	35.20	3.00	21.90	29.10	3.60
14	27.00	32.50	3.20	22.22	17.21	16.05	33.50	38.40	3.00	25.00	32.50	3.60
16	30.30	34.80	3.20	25.40	17.21	16.05	33.50	41.00	3.00	28.20	34.80	3.60
18	33.70	38.20	3.20	28.57	17.21	16.05	33.50	44.70	3.00	31.40	38.20	3.60
20	37.00	41.60	3.20	31.75	17.21	15.29	33.50	47.90	3.00	34.60	41.60	3.60
22	40.40	45.00	3.20	34.90	17.21	15.29	33.50	51.00	3.00	37.60	45.00	3.60
24	43.40	49.50	3.77	38.10	18.20	15.29	33.50	55.80	3.00	41.00	49.50	4.10

Note: All dimensions are in millimeters (mm)

8STA series shell sizes 08 to 24

Ordering information

Jam nut receptacle

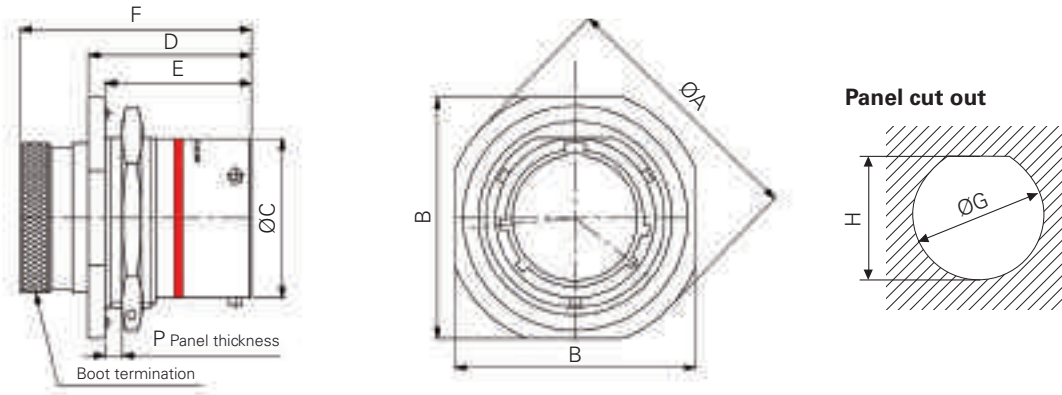

Shell size	ØA ± 0.3	B ± 0.24	ØC ± 0.12	D ± 0.10	E ± 0.24	F ± 0.3	P max.	ØG ± 0.10	H ± 0.20	Tightening torque (mN)
08	26.90	24.10	11.97	25.91	23.24	36.71	3.00	14.50	13.60	4
10	30.15	27.30	14.94	25.91	23.24	36.71	3.00	17.70	16.80	6
12	34.89	32.10	19.01	25.91	23.24	36.71	3.00	22.70	20.90	9
14	38.06	34.92	22.18	25.91	23.24	36.71	3.00	25.70	24.10	10
16	41.25	38.40	25.36	25.91	23.24	36.71	3.00	28.80	27.20	13
18	44.41	41.60	28.53	26.71	23.24	37.51	3.00	32.00	30.40	20
20	49.19	46.30	31.71	26.71	23.24	37.51	3.00	35.10	33.60	23
22	52.33	49.50	34.88	26.71	23.24	37.51	3.00	38.00	36.80	25
24	55.50	52.45	38.06	26.71	23.24	37.51	3.00	42.00	39.90	26

Orientations

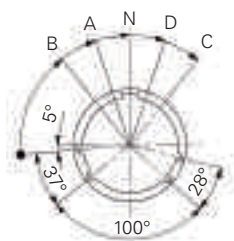

Viewed from face of receptacle

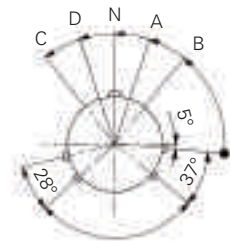

Viewed from face of plug

Shell size	N Red	A Yellow	B Blue	C Orange	D Green
08	95°	77°	-	-	113°
10	95°	81°	67°	123°	109°
12	95°	75°	63°	127°	116°
14	95°	74°	61°	129°	116°
16	95°	77°	65°	125°	113°
18	95°	77°	65°	125°	113°
20	95°	77°	65°	125°	113°
22	95°	80°	69°	121°	110°
24	95°	80°	69°	121°	110°

For each shell size, U orientation can be mateable with any other orientations.

Note: All dimensions are in millimeters (mm)



Description

- A #4 contact for a wide range of wire sizes: Size 8, 10, 16, 25 & 35 mm²
- Easy visual wire identification: Color band on contact
- Allow the use of small wire sections: Reducer for wires 8 & 10 mm² in contact barrel 16mm²
- Ideal for high power applications: Up to 200A continuous (12-01 specif. 261)
- Space & cost saving with mixed connectors: Only one connector instead of two to transmit signal & power

Technical specifications

Mechanical

Shell

Aluminium alloy

Shell plating

Conductive black zinc

Insulator

Thermoplastic

Grommet & seal

Liquid silicone rubber

Contact

Copper alloy

Contact plating

Gold over nickel

Endurance

500 mating cycles

Shock

300g for 3ms and EIA-364-27

Vibration

147m/s², 10 to 2000Hz

Contact retention

Size 22D:	45 N
Size 20:	60 N
Size 16:	100 N
Size 12:	100 N
Size 8:	110 N
Size 4:	200 N

Electrical

Test voltage

Service	M	N	I	II
Sea level	1,300	1,000	1,800	2,300

Contact resistance

Size 22D:	14.6 mΩ
Size 20:	7.3 mΩ
Size 16:	3.8 mΩ
Size 12:	3.5 mΩ
Size 8:	3 mΩ
Size 4:	2 mΩ

Insulation resistance

≥ 5000 MΩ (at 500 Vdc)

Contact rating

Size 22D:	5 A
Size 20:	7.5 A
Size 16:	13 A
Size 12:	23 A
Size 8:	45 A
Size 4:	80 A

Shell continuity

≤10 mΩ

Environmental

Operating temperature

-55°C to +175°C

Sealing mated connectors

IP67 (1 meter for 30 min minimum)

Salt spray

48 hours

8STA series power contacts

Contact layouts

Contact layouts viewed from front face of male insulator

Contact sizes ○ #22D ● #20 ◐ #16 ◑ #12 ◒ #8 Power ◓ #4 Power

10

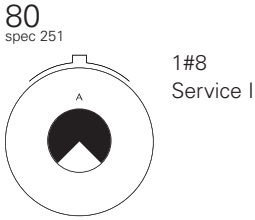

12

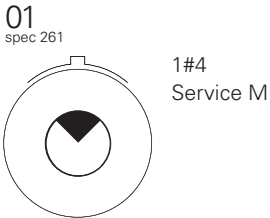

16

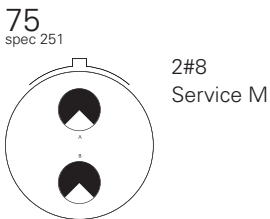
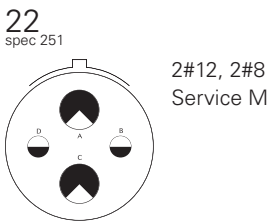
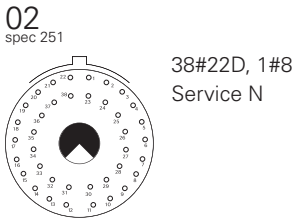

18

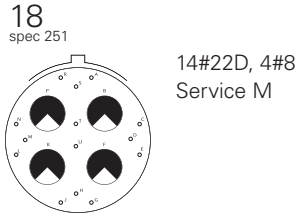

20

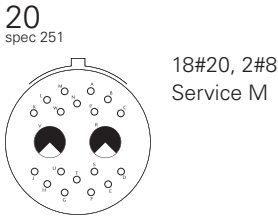

42

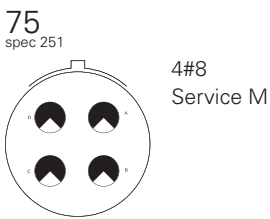
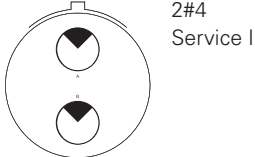

20

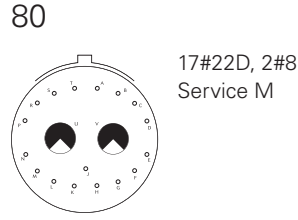

22

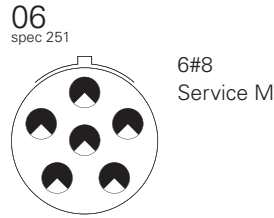

24

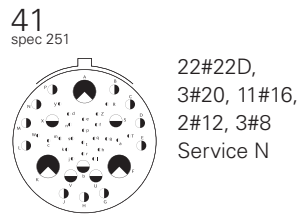
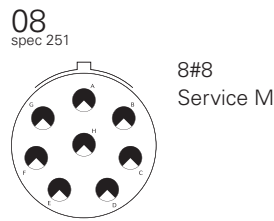
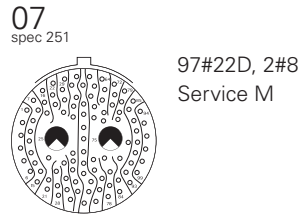

24

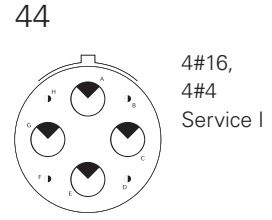

Part numbers

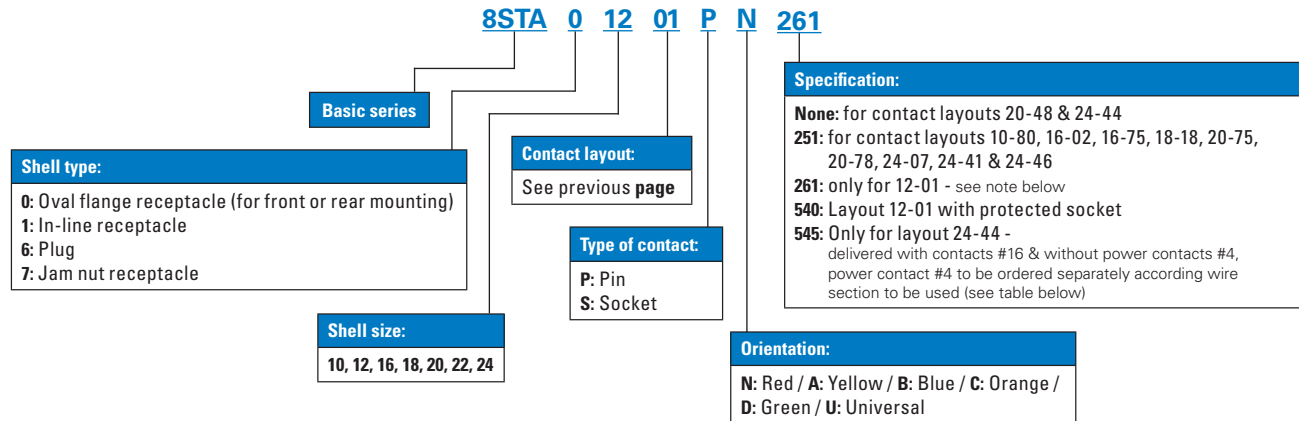

Note: Layout 12-01 specif. 261 only.

- 1) Standard connector (8STAx1201yz261 where x = shell type; y = type of cts; z = orientation) is provided with power contacts for 16mm² wire.
- 2) For 10mm² wire, order standard connector (note 1) + reducing sleeve 8400 2351 A separately.
- 3) For 25mm² wire, order connector without contact, see A & B details in type of contact (ex : 8STAx1201Az261 or Bz261) + contact separately (pin : 8599 7598 900 & socket : 8599 7599 900)
- 4) For 35mm² wire, order connector without contact, see A & B details in type of contact (ex : 8STAx1201Az261 or Bz261) + contact separately (pin : 8599 0313 & socket : 8599 0316)

Power contacts

Designation	Wire 16 mm ²	Wire 25 mm ²	Wire 35 mm ²
	Removable contact	Removable contact	Non removable contact
Color band	Red	Blue	Green
Pin contact	8599 7520A 900	8599 7598 900	8599 0313
Socket contact	8599 7521A 900	8599 7599 900	8599 0316
Reducer - wire 8 & 10 mm²	8400 2351A	-	-
Crimping tool	M22520/23-01 + Die M22520/23-04 + Positionner M22520/23-11 And for widerer 50 mm ² : M22520/23-01+ Die WA23-4 + Positionner WA23-176L	M22520/23-01 + Die M22520/23-04 + Positionner M22520/23-11	M22520/23-01 + Die 8599-0319 + Positionner 8599-0318 (male) + Positionner 8599-0317 (female)
Plastic extraction tool	M81969/14-07 (blue)	M81969/14-07 (blue)	-

Specific wire dimensions

Power contact #4

Pin contact

Socket contact

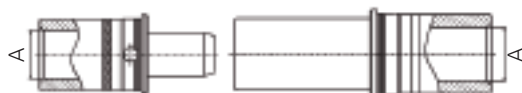

Cable section	A		
	16 mm ²	25 mm ²	35 mm ²
Contact Ø	6.5 Min.	7.33 Min.	8.65 Min.
Color band	Red	Blue	Green

Reducer for wire 8 and 10 mm²

Compatible with pin and socket contact, wire 16 mm²



Note: All dimensions are in millimeters (mm)

8STA series high density

Technical specifications



Description

- Rugged aluminium body to ensure long service life in the harshest environment
- 100% scoop proof
- Available in 6 shell sizes: 02-05; 04-06; 06-09; 08-12; 10-26; 12-43; 14-68
- Contacts #26 for AWG 24 to 30

Technical specifications

Mechanical

Shell

Aluminium alloy

Shell plating

Conductive black zinc
Nickel (F)

Insulator

Thermoplastic

Grommet & seal

Liquid silicone rubber

Contact

Copper alloy

Contact plating

Gold

Endurance

500 mating cycles

Shock

300g for 3ms and EIA-364-27

Vibration

147m/s², 10 to 2000Hz

Electrical

Contact resistance

Size 26: 16mΩ

Insulation resistance

≥5000MΩ (at 500Vdc)

Contact rating

Size 26: 3 Amp

Shell continuity

≤10 mΩ

Environmental

Operating temperature

-55°C to +175°C

Sealing mated connectors

IP67 (1 meter for 30 min minimum)

Salt spray

48 hours

Part numbers

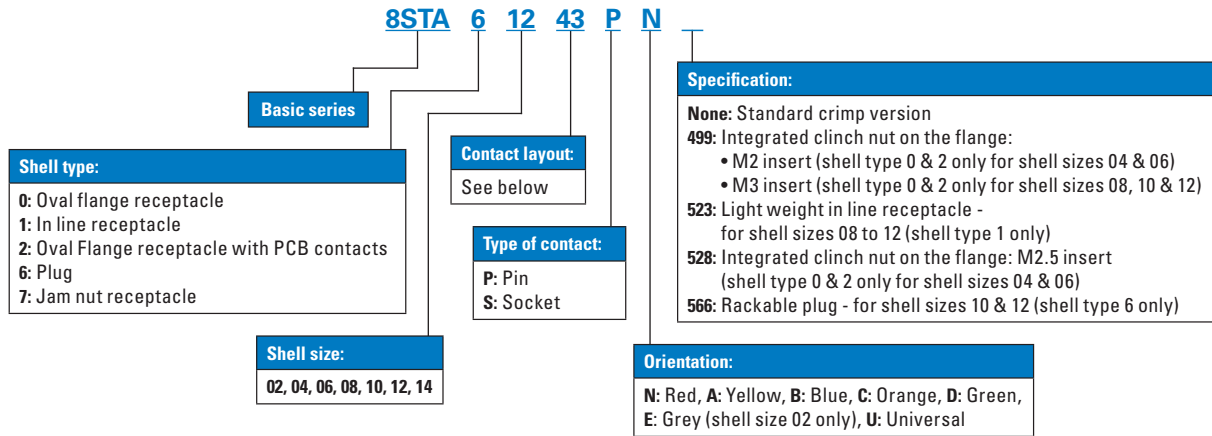

Contact layouts (viewed from front face of male insulator)

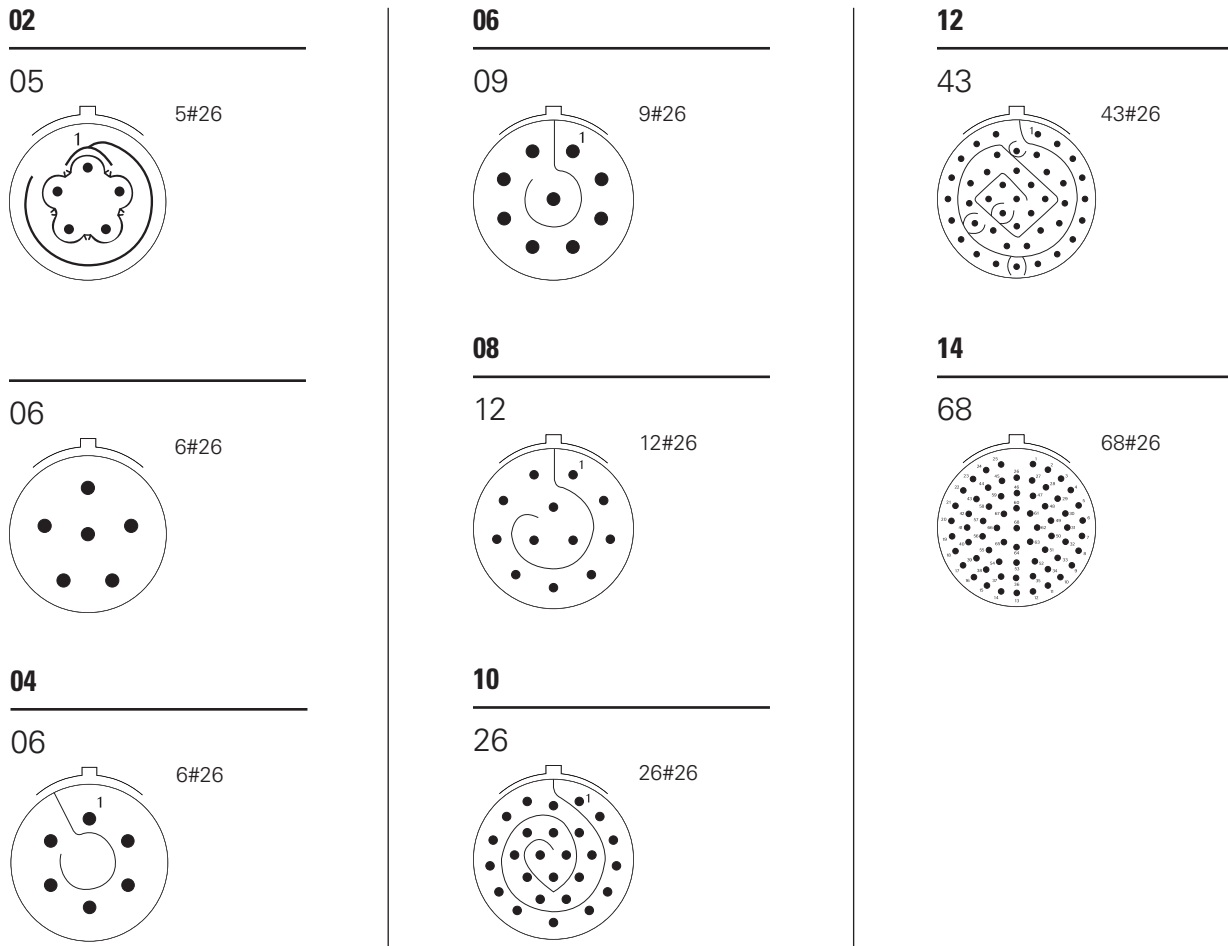

8STA series integrated clinch nuts

Technical specifications



Description

- A convenient and time saving feature - weight saving opportunities: elimination of nut plates
- Souriau offering:
 - 12 shell sizes available, from size 02 to 24
 - Available with standard crimp contacts (shell type 0) and PCB contacts (shell type 2)

Technical specifications

Mechanical

Shell

Aluminium alloy

Shell plating

Conductive black zinc

Insulator

Thermoplastic

Grommet & seal

Liquid silicone rubber

Contact

Copper alloy

Contact plating

Gold

Endurance

500 mating cycles

Shock

300g for 3ms and EIA-364-27

Vibration

147m/s², 10 to 2000Hz

Contact retention

Size 26:	35 N
Size 22D:	45 N
Size 20:	60 N
Size 16:	100 N
Size 12:	100 N
Size 8:	110 N
Size 4:	200 N

Electrical

Please see page 16 for sizes 02 to 06, and page 19 for sizes 08 to 24

Environmental

Operating temperature

-55°C to +175°C

Sealing mated connectors

IP67 (1 meter for 30 min minimum)

Salt spray

48 hours

Current solution:



Connector + extra nut plate fixed on the rear connector side.

NEW solution:



Integrated clinch nuts on the flange = Cost and time saving!

Part numbers

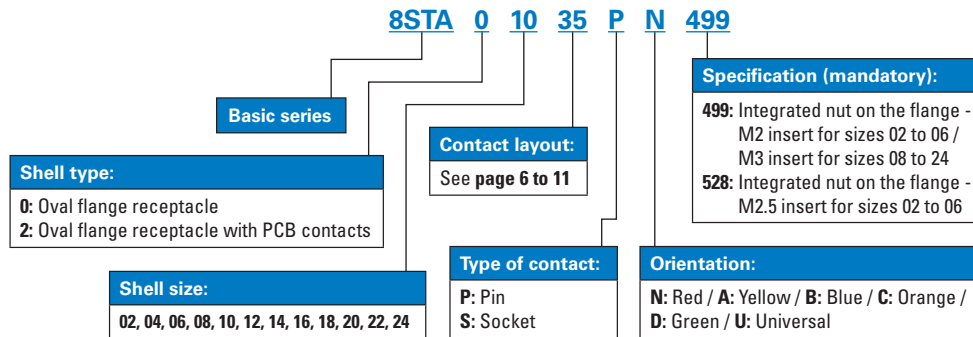

Dimensions

Oval flange receptacle

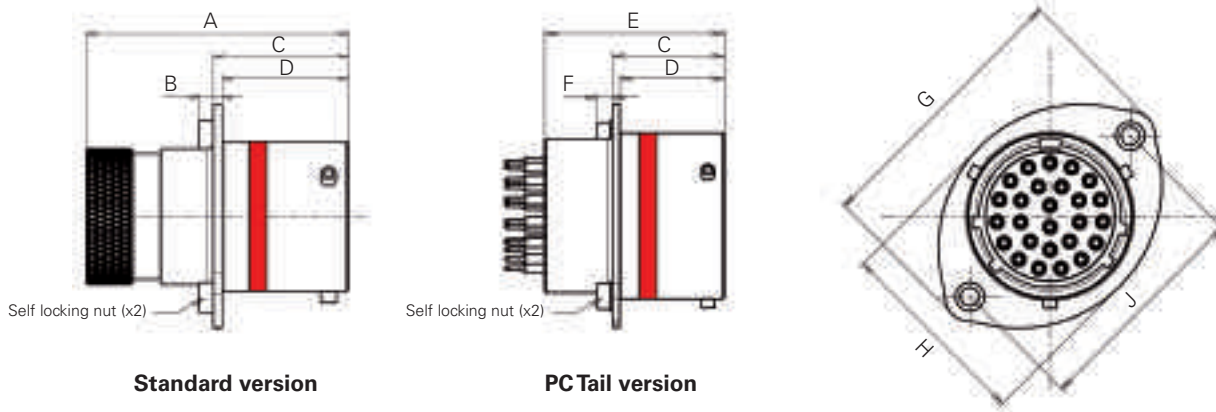

Shell size	A	B	C	D	E max.	F	G max.	H max.	J ^{±0.20}
02	16.30	3.22	10.15	8.80	17.5	2.05	21.4	10.50	15.4
04	18.30	3.37	10.7	9.2	18.3	2.05	22.3	13.2	16.4
06	23.25	3.83	12.95	10.95	23.25	2.05	24.0	15.0	18.2
08	33.4	3.32	17.21	16.05	27.65	2.72	29.25	16.50	21.40
10	33.4	3.32	17.21	16.05	27.65	2.72	33.75	19.50	25.90
12	33.4	3.32	17.21	16.05	27.65	2.72	36.95	24.00	29.10
14	33.4	3.32	17.21	16.05	27.65	2.72	40.35	27.00	32.50
16	33.4	3.32	17.21	16.05	27.65	2.72	42.65	30.30	34.80
18	33.4	3.32	17.21	16.05	27.65	2.72	46.05	33.70	38.20
20	33.4	3.32	17.21	15.29	27.65	2.72	49.45	37.00	41.60
22	33.4	3.32	17.21	15.29	27.65	2.72	52.85	40.40	45.00
24	33.4	3.32	18.20	15.29	27.65	2.72	57.35	43.40	49.50

For other dimensions please see:
Page 18 for standard version sizes 02 to 06
Page 21 for standard version sizes 08 to 24
Page 44 for PC-tail version sizes 02 to 24

Note: All dimensions are in millimeters (mm)

8STA series single hole fixing

Technical specifications



Description

- Half flange weight saving connector
- Derived from MIL-DTL-38999 & JN1003 standard
- 100% scoop proof
- Available from 02 to 24 shell sizes
- Clinch nuts or PCB version available

Technical specifications

Mechanical

Shell

Aluminium alloy

Shell plating

Conductive black zinc:
Nickel (F)

Insulator

Thermoplastic

Grommet & seal

Liquid silicone rubber

Contact

Copper alloy

Contact plating

Gold

Endurance

500 mating cycles

Shock

300g for 3ms and EIA-364-27

Vibration

147m/s², 10 to 2000Hz

Contact retention

Size 26:	35 N
Size 22D:	45 N
Size 20:	60 N
Size 16:	100 N
Size 12:	100 N
Size 8:	110 N
Size 4:	200 N

Electrical

Test voltage

Service	Sea level	@21,000m
R	400	N/A
S	1,000	N/A
M	1,300	800
N	1,000	600
I	1,800	1,000
II	2,300	1,000

Contact resistance

Size 26:	<16 mΩ
Size 22D:	14.6 mΩ
Size 20:	7.3 mΩ
Size 16:	3.8 mΩ
Size 12:	3.5 mΩ
Size 8:	3 mΩ
Size 4:	2 mΩ

Insulation resistance

≥ 5000MΩ @ 400Vdc / Size 26
≥ 5000MΩ @ 500Vdc / All other sizes

Contact rating

Size 26:	3 Amp
Size 22D:	5 A
Size 20:	7.5 A
Size 16:	13 A
Size 12:	23 A
Size 8:	45 A
Size 4:	80 A

Shell continuity

≤10 mΩ

Environmental

Operating temperature

-55°C to +175°C

Sealing mated connectors

IP67 (1 meter for 30 min minimum)

Salt spray

Aluminum nickel: 48 hours
Aluminum conductive black zinc:
48 hours

Part numbers

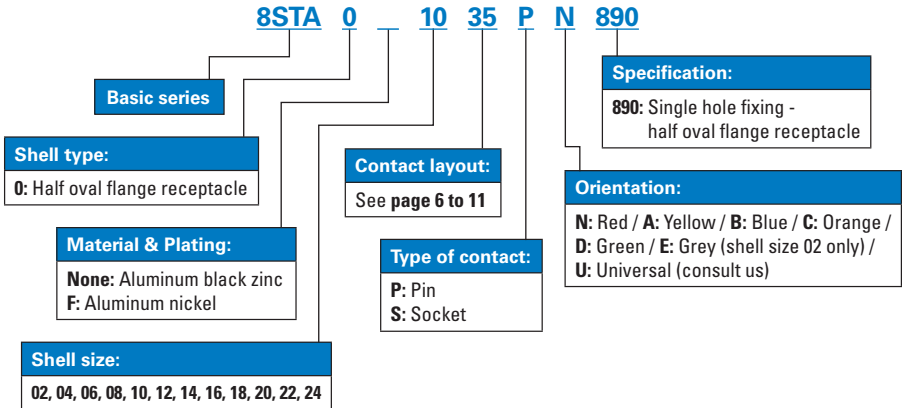

For any other configuration (clinch nuts, PC tail, etc.) please consult us.

Dimensions

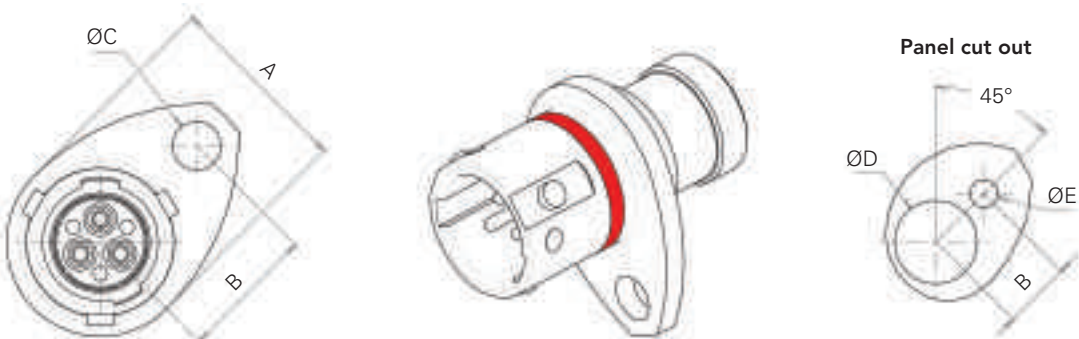

Size	02	04	06	08	10	12	14	16	18	20	22	24
A max.	10.7/0.42"	13.2/0.52"	14.9/0.59"	16.5/0.65"	19.5/0.77"	24.0/0.94"	27.0/1.06"	30.3/1.19"	33.7/1.33"	37.0/1.46"	40.4/1.59"	43.4/1.71"
B^{Ø1}	7.65/0.30"	8.1/0.32"	9.0/0.35"	10.7/0.42"	12.95/0.51"	14.55/0.57"	16.25/0.64"	17.4/0.69"	19.1/0.75"	20.8/0.82"	22.5/0.89"	24.75/0.97"
ØC max.	2.80/0.11"	2.80/0.11"	2.80/0.11"	3.20/0.13"	3.20/0.13"	3.20/0.13"	3.20/0.13"	3.20/0.13"	3.20/0.13"	3.20/0.13"	3.20/0.13"	3.77/0.15"
ØD^{Ø1}	9.3/0.37"	12.0/0.47"	13.0/0.51"	14.5/0.57"	17.4/0.69"	21.9/0.86"	25.0/0.98"	28.2/1.11"	31.4/1.24"	34.6/1.36"	37.6/1.48"	41.0/1.61"
ØE^{Ø2}	3.10/0.12"	3.10/0.12"	3.10/0.12"	3.60/0.14"	3.60/0.14"	3.60/0.14"	3.60/0.14"	3.60/0.14"	3.60/0.14"	3.60/0.14"	3.60/0.14"	4.10/0.16"

Note: All dimensions are in millimeters and inches (mm/inch).

8STA series quick release for steering boss system

Technical specifications



Description

- Rugged aluminium body to ensure long service life in the harshest environment
- 100% scoop proof
- Available in 2 shell sizes: 10 and 12, please consult us for other sizes
- Standard insulators shell sizes 10 and 12 available

Technical specifications

Mechanical

Shell

Aluminium

Shell plating

Conductive black zinc

Insulator

Thermoplastic

Grommet & seal

Liquid silicone rubber

Contact

Copper alloy

Contact plating

Gold

Endurance

500 mating cycles

Shock

300g for 3ms and EIA-364-27

Vibration

147m/s², 10 to 2000Hz

Electrical

Contact resistance

Size 22D: 14.6 mΩ

Insulation resistance

≥ 5000MΩ @ 500Vdc

Contact rating

Size 22D: 5 Amp

Shell continuity

≤10 mΩ

Environmental

Operating temperature

-55°C to +175°C

Sealing mated connectors

IP67 (1 meter for 30 min minimum)

Salt spray

48 hours

Part numbers

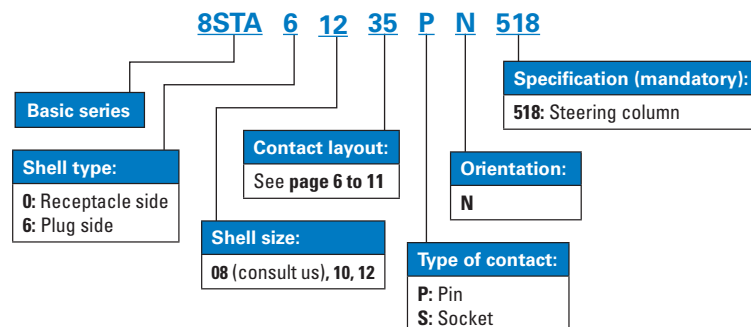

Dimensions

Shell size 10

Female Receptacle

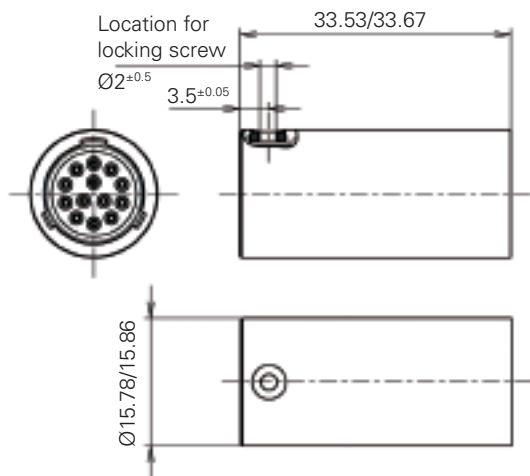

Male Plug

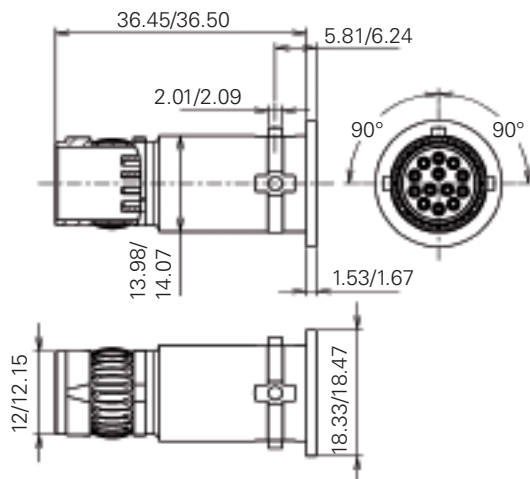

Shell size 12

Female Receptacle

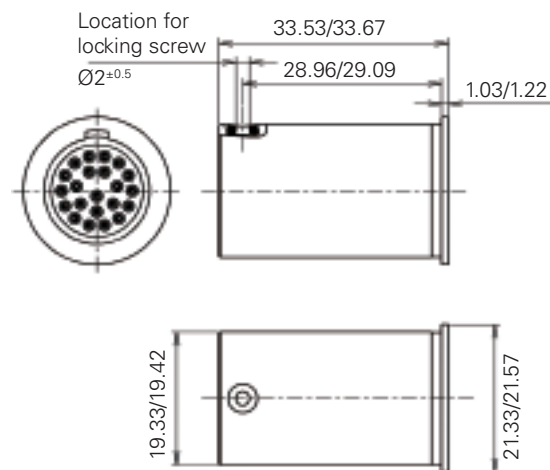

Male Plug

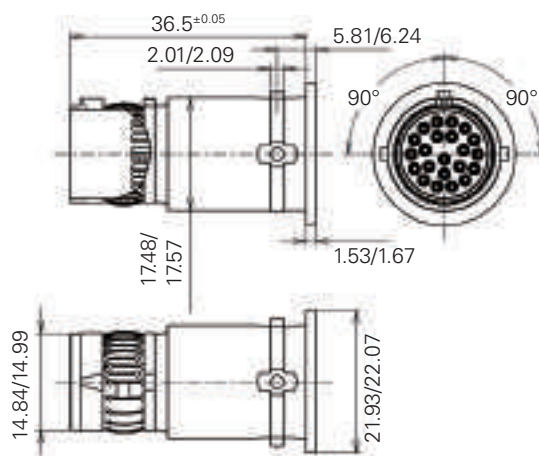

Mounting dimension requirement

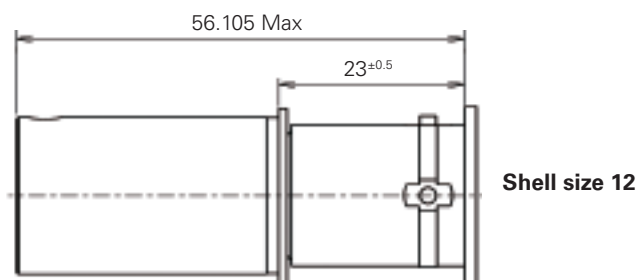
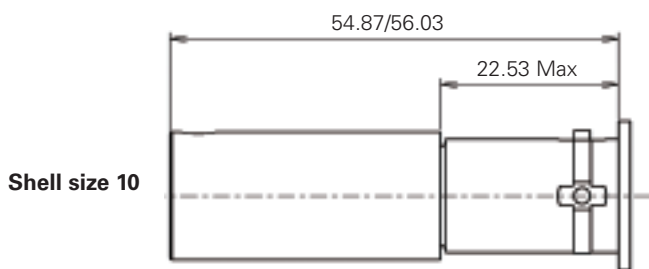

Note: All dimensions are in millimeters (mm)

Blind mating plug sizes 08 to 24

Technical specifications



Description

- Blind mating solution for quick connection in hard-to-reach areas.
- Specific 8STA plug: compensating for misalignment in 3 axes
- Blind connection:
 - Easy and fast connection without any coupling/uncoupling between float-mounting unit and fixed unit
 - 100% Scoop proof
- A versatile product:
 - Available in sizes 10, 12, 14 and 16
 - All layouts according connector shell size
 - Available in crimp contacts
- Mandatory mating part: standard jam nut receptacle 8STA7

Technical specifications

Mechanical

Shell

Aluminium alloy

Shell plating

Conductive black zinc

Insulator

Thermoplastic

Grommet & seal

Liquid silicone rubber

External cover

Green fluoro silicone

Contact

Copper alloy

Contact plating

Gold

Contact retention

Size 22D: 45N Size 20: 60N
 Size 16: 100N Size 12: 100N
 Size 8: 110N Size 4: 200N

Flange dimension

- Flange of plug size 16 equivalent to flange of receptacle size 22
- Flange of plug size 14 equivalent to flange of receptacle size 20
- Flange of plug size 12 equivalent to flange of receptacle size 18
- Flange of plug size 10 equivalent to flange of receptacle size 16

Electrical

Test voltage

Service	M	N	I	II
Sea level	1300	1000	1800	2300

Contact resistance

Size 22D:	4.6 mΩ
Size 20:	7.3 mΩ
Size 16:	3.8 mΩ
Size 12:	3.5 mΩ
Size 4:	2 mΩ

Insulation resistance

≥ 5000 MΩ (at 500 Vdc)

Contact rating

Size 22D:	5A
Size 20:	7.5A
Size 16:	13A
Size 12:	23A
Size 8:	45A
Size 4:	80A

Environmental

Temperature range

-55°C to +175°C

Sealing mated connectors

IP67 (1 meter for 30 min. minimum)

Salt spray:

48 hours

Compensating for misalignment in 3 axes

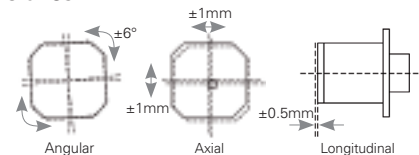

Part numbers

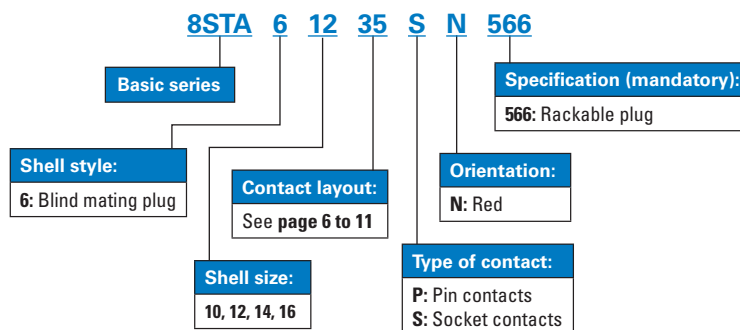

Note: Receptacle to be used with rackable plug = 8STA7xxxxx (standard jam nut version)

Dimensions

Plug type 6

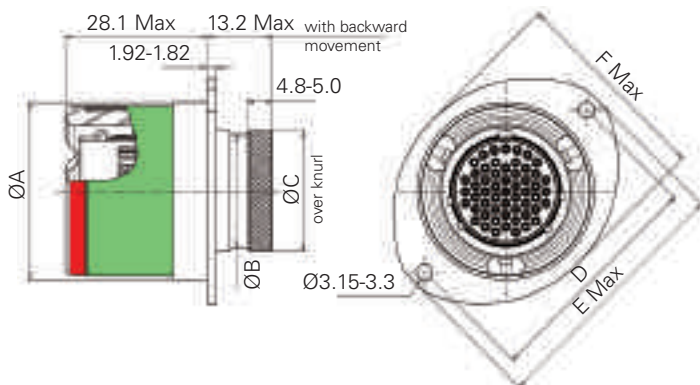

Mated Connector

(plug type 6 & jam nut receptacle type 7)

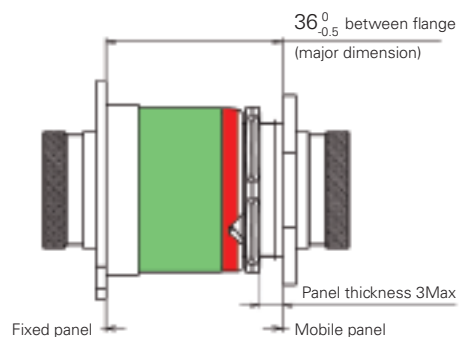

Shell size	$\text{ØA}^{+0.3}_0$	$\text{ØB}^{+0.2}_0$	ØC	$\text{D}^{+0.4}_0$	E	F
10	25.17	12.85	13.72	34.60	41.00	30.30
12	28.35	15.92	17.26	38.00	44.70	33.70
14	31.52	18.90	20.41	41.40	47.90	37.00
16	34.70	22.08	23.60	44.80	51.00	40.40

Note: All dimensions are in millimeters (mm)

8STA series hermetic connectors

Technical specifications



Description

- Bayonet coupling connector
- Glass sealed hermetic:
 - high hermeticity performance
 - compact low profile
- Various mounting styles:
 - compact solder mount receptacle
 - easy to replace jam nut receptacle
- Solder cup or PC tail contacts
- Specific fuel tank version for long term fuel immersion

Technical specifications

Mechanical

Shell

Stainless steel

Shell plating

Passivated

Insulator

Glass bead

Contact

Nickel iron

Contact plating

Gold

Endurance

500 mating cycles

Electrical

Test voltage

Service I: 1800V
Service M: 1300V

Contact resistance

2 mΩ

Insulation resistance

≥ 5000MΩ (at 500Vdc)

Contact rating

Size 16: 10 A
Size 20: 5 A
Size 22D: 3 A
Size 26: 1.8 A

Environmental

Operating temperature

-55°C to +175°C

Sealing mated connectors

IP67 (1 meter for 30 min minimum)

Salt spray

48 hours

Hermeticity

Leak rate < 1.10⁻⁷ atm.cm³/s
(helium gas test)

Part numbers

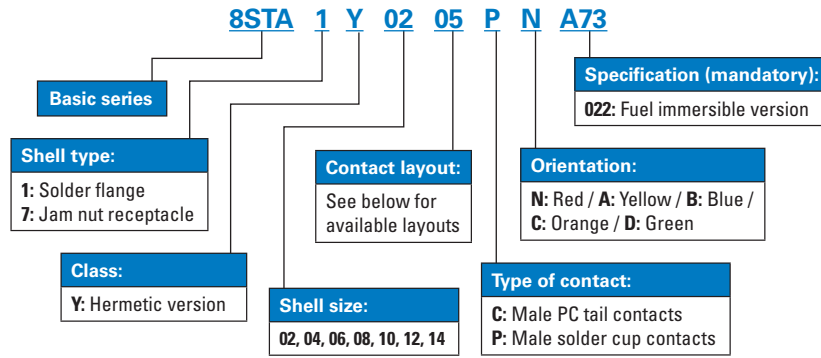

Contact layouts (viewed from front face of male insulator)

● Contact #26 ○ Contact #22D ◐ Contact #20 ◑ Contact #16

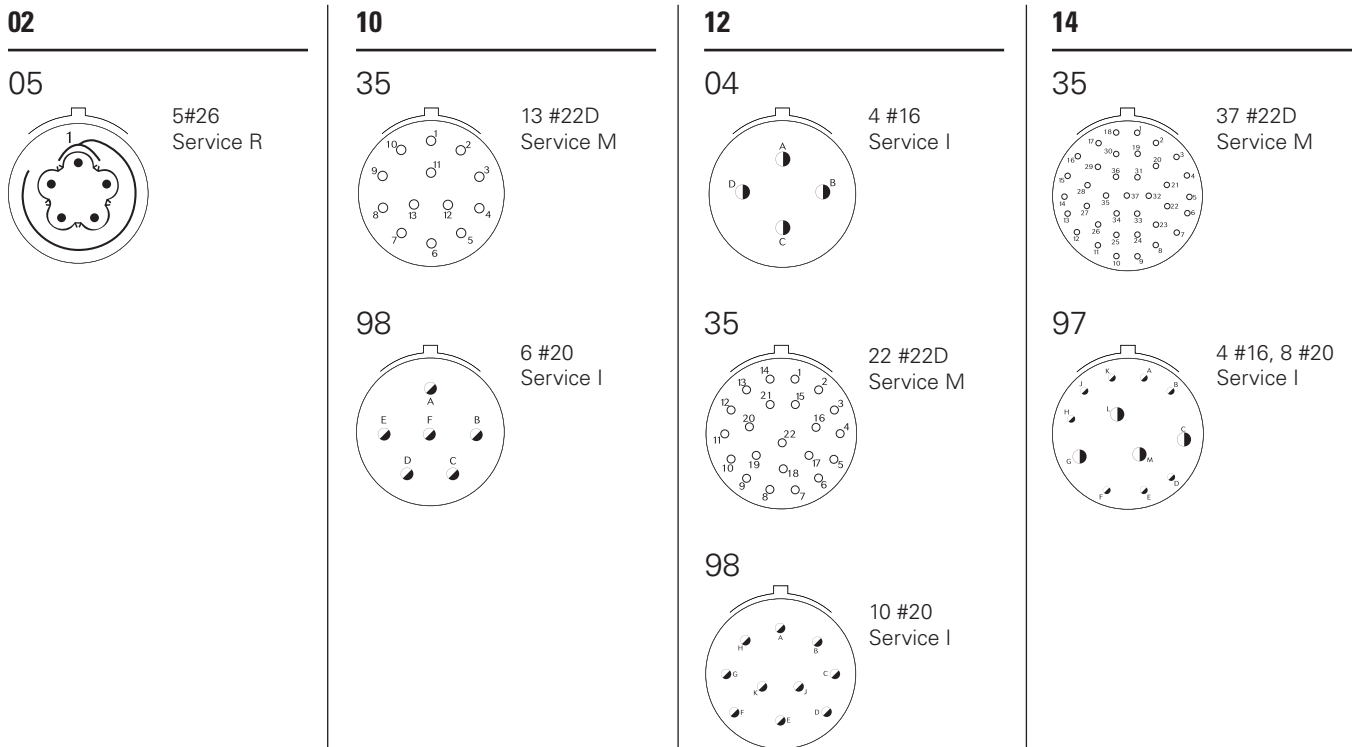

8STA series hermetic connectors

Ordering information

Contact layouts (matrix)

Shell size	Layout	Hermetic 8STA	Number of contacts				
			#26	#22D	#20	#16	#12
02	02-05	OK	5				
	02-35	Available on request, please consult us		3			
04	04-05	Available on request, please consult us	5				
	04-06	Available on request, please consult us	6				
	04-35	Available on request, please consult us		3			
06	06-05	Available on request, please consult us	5				
	06-09	Available on request, please consult us	9				
	06-35	Available on request, please consult us		5			
08	08-12	Available on request, please consult us	12				
	08-35	Available on request, please consult us		6			
	08-98	Available on request, please consult us			3		
10	10-02	Available on request, please consult us				2	
	10-04	Available on request, please consult us			4		
	10-05	Available on request, please consult us			5		
	10-22	Available on request, please consult us		4			
	10-26	Available on request, please consult us	26				
	10-35	OK		13			
	10-98	OK			6		
12	12-03	Available on request, please consult us				3	
	12-04	OK				4	
	12-08	Available on request, please consult us			8		
	12-26	Available on request, please consult us		6			2
	12-35	OK		22			
	12-43	Available on request, please consult us	43				
	12-98	OK			10		
14	14-05	Available on request, please consult us				5	
	14-15	Available on request, please consult us			14	1	
	14-18	Available on request, please consult us			18		
	14-19	Available on request, please consult us			19		
	14-35	OK		37			
	14-68	Available on request, please consult us	68				
	14-97	OK			8	4	

OK = Souriau's layout

Dimensions

Solder flange receptacle - size 02

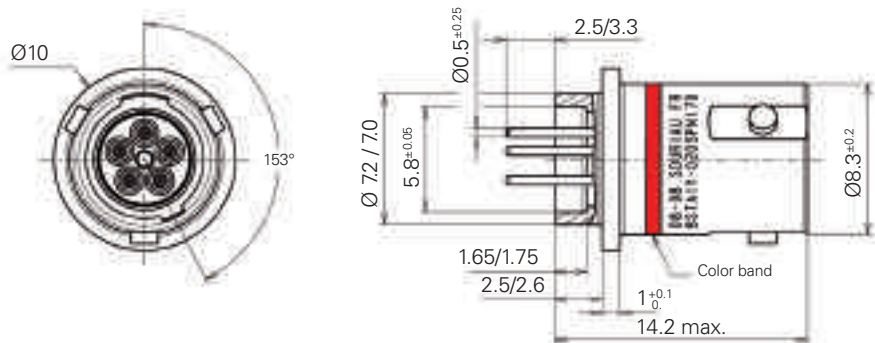

Please consult us for other shell sizes.

Note: All dimensions are in millimeters (mm)

Dimensions

Jam nut receptacle - sizes 10 to 14

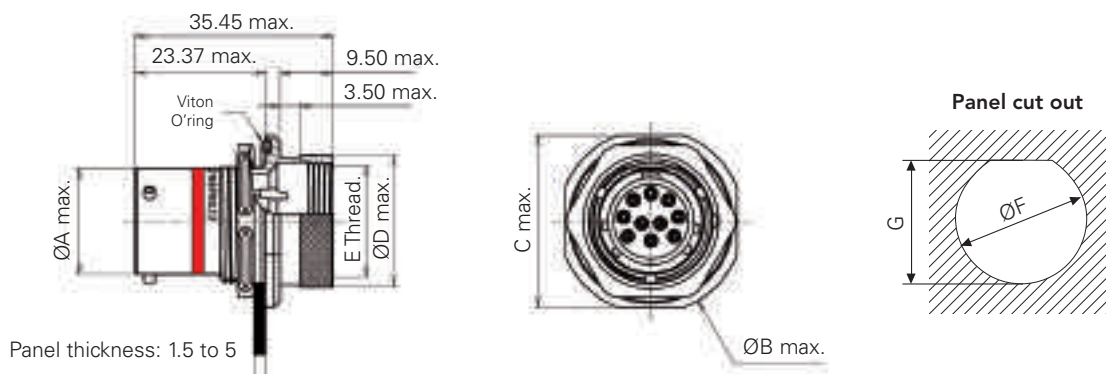

Shell size	Ø A max.	Ø B max.	C max.	Ø D max.	E Thread	Panel cut out	
						Ø F ^{+0.10}	G ^{+0.20}
10	15.04	28.40	25.95	20.50	M18 x 1	17.70	16.80
12	19.09	33.00	30.75	23.67	M21 x 1	22.70	20.90
14	22.26	36.30	33.85	26.84	M24 x 1	25.70	24.10

Please consult us for other shell sizes.

Connector weight

Shell size	Receptacle type	Maximum weight in grams
02	In-line	2.5
10	Jam nut	35
12	Jam nut	52
14	Jam nut	63

Note: All dimensions are in millimeters (mm)

8STA series hermetic feedthrough

Technical specifications



Description

- Solder contacts on both sides of bulkhead
- Designed for high vibration environment
- Wire soldered on both sides of the feed-through: no plugs needed
- Cost and space saving:
 - Adapted to space-constrained area
 - No plugs necessary
- Easy to solder:
 - Contacts fully tin plated
 - Different contact sizes available
- High performance sealing: <math>< 1.10^{-7}</math> atm.cm³/s

Technical specifications

Mechanical

Shell

Stainless steel

Shell plating

Passivated

Insulator

Glass bead

Contact

Nickel iron, tin plated

Electrical

Test voltage

Service M: 1300V

Contact resistance

2 m Ω

Insulation resistance

$\geq 5000\text{M}\Omega$ (at 500Vdc)

Contact rating

Size 22D: 3 A

Environmental

Operating temperature

-55°C to +175°C

Sealing mated connectors

IP67 (1 meter for 30 min minimum)

Salt spray

48 hours

Hermeticity

1.10⁻⁷cm³/s

Contact layouts (viewed from front face of male insulator)

12

35

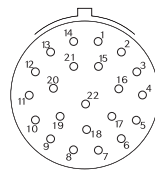

22#22D
Service M

Consult us for other layouts or shell sizes.

Part numbers

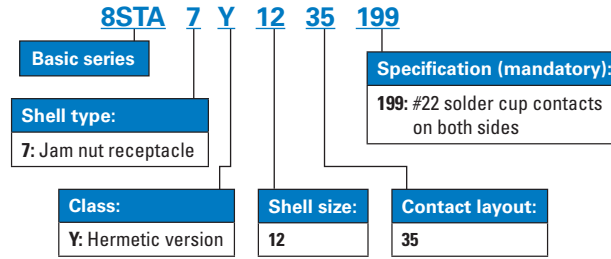

Note: Delivery will contain the cup for potting and the jam nut receptacle not mounted. Consult us for other layouts or shell sizes.

Dimension

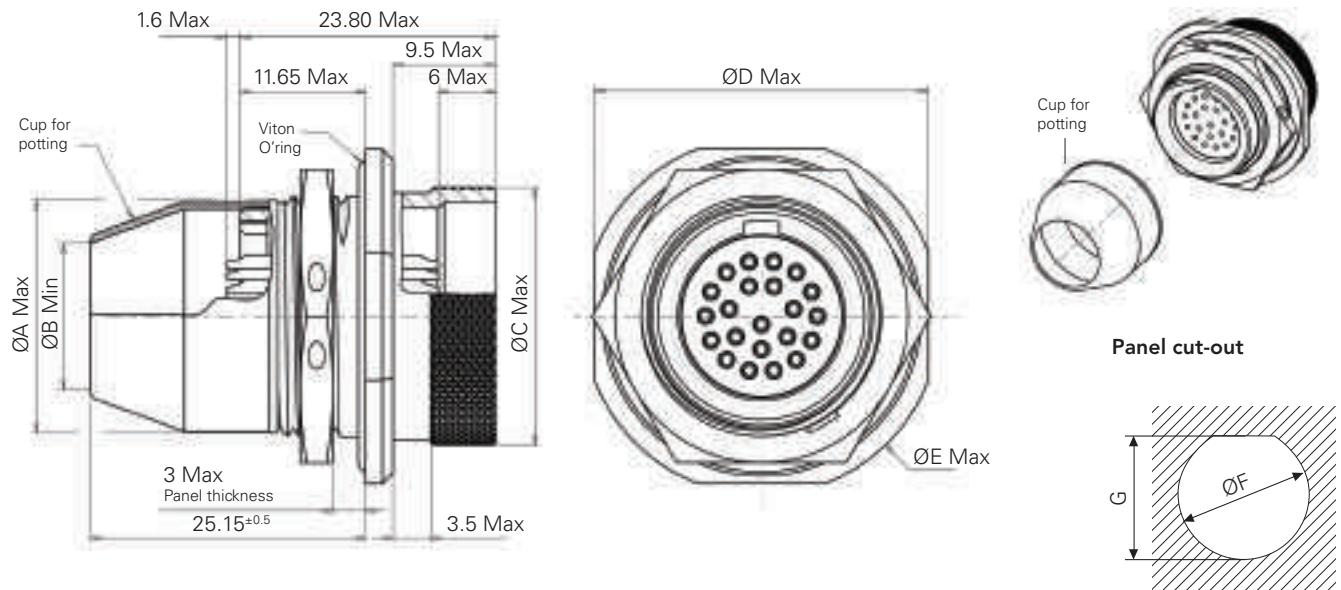

Size	A	B	C	D	E	F	G
12	21.70	12.90	23.70	30.85	33.00	22.70	20.90

Note: All dimensions are in millimeters (mm)

8STA series PC tail contacts

Technical specifications



Description

- Rugged aluminium body to ensure long service life in the harshest environment
- 8STA PCB connectors are available in shell sizes 02 to 24 (12 sizes)
- 100% scoop proof
- Available with clinch nut
- 6 color coded keyway orientations

Technical specifications

Mechanical

Shell

Aluminium

Shell plating

Conductive black zinc

Insulator

Liquid silicone rubber

Seal

Liquid silicone rubber

Contact

Copper alloy

Contact plating

Gold

Endurance

500 matings/unmatings

Shock

300g for 3ms and EIA-364-27

Vibration

147m/s², 10 to 2000 Hz

Electrical

Contact resistance

Size 26:	16 mΩ
Size 22D:	14.6 mΩ
Size 20:	7.3 mΩ
Size 16:	3.8 mΩ

Insulation resistance

≥ 5000MΩ (at 500Vdc)

Contact rating

Size 26:	3 Amp
Size 22D:	5 Amp
Size 20:	7.5 Amp
Size 16:	13 Amp

Shell continuity

≤ 10mΩ

Environmental

Temperature range

-55°C to +175°C

Sealing mated connectors

IP67 (1 meter for 30 min minimum)

Salt spray

48 hours

Part numbers

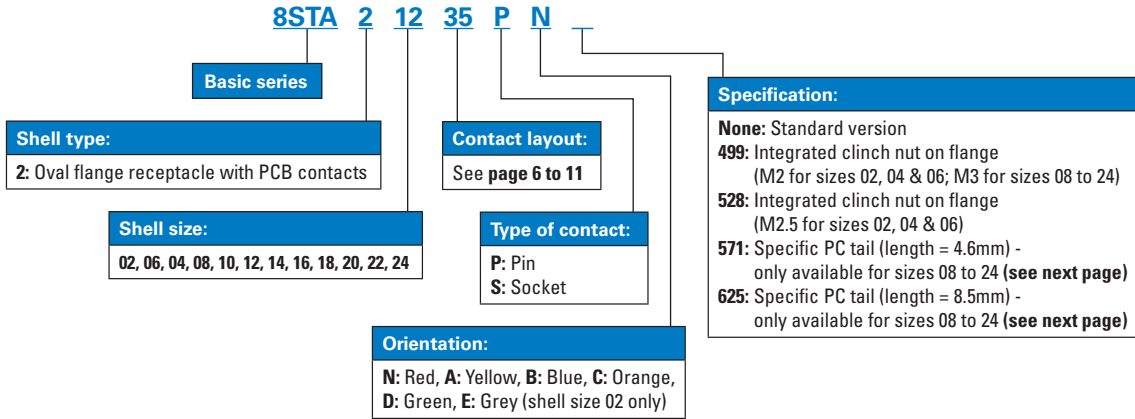

Dimensions

Shell sizes 02, 04 & 06

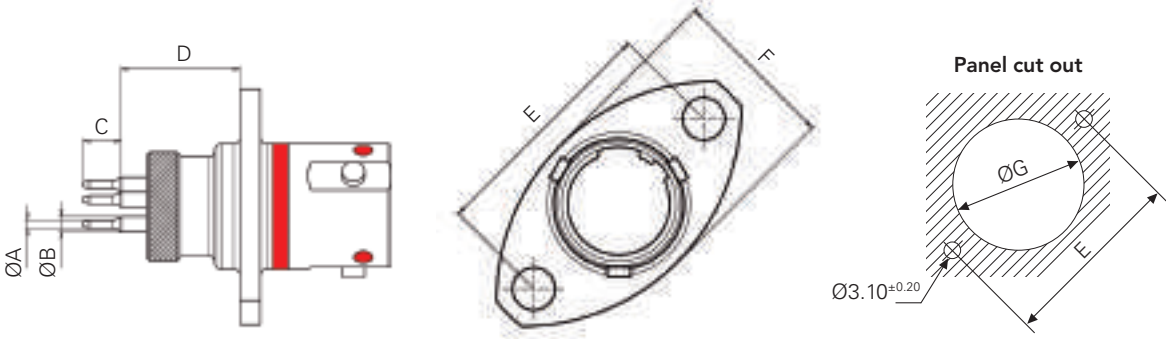

Contact size	ØA Max	ØB Max
#22D	0.70	1.25
#26	0.55	1.16

Shell size	C Max	D max	E	F Max	ØG
02	2.5	9.5	15.3 ^{+0.2}	10.7	9.3 ^{+0.1}
04	2.5	8.7	16.2 ^{+0.2}	13.2	12.0 ^{+0.1}
06	4.1	14.7	18.0 ^{+0.2}	14.8	13.0 ^{+0.1}

Note: All dimensions are in millimeters (mm)

8STA series PC tail contacts

Ordering information

Shell sizes 08 to 24

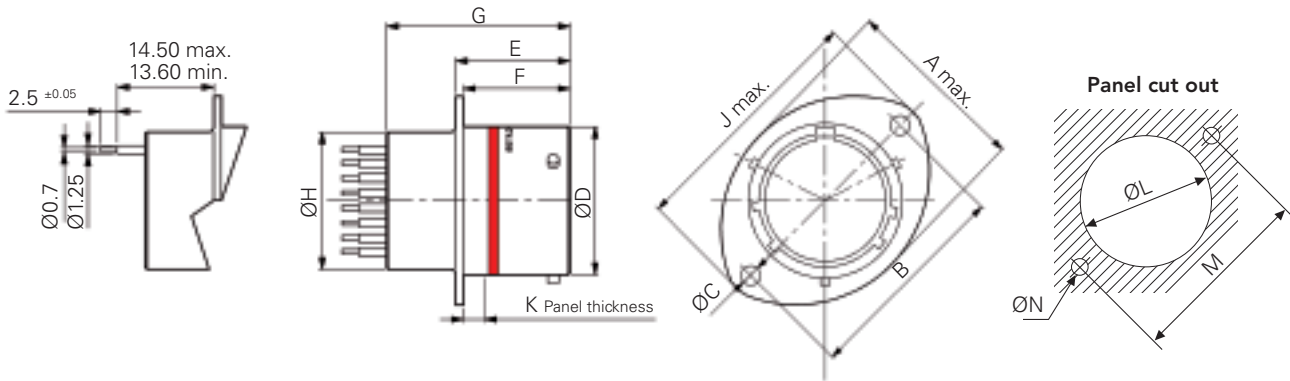

Shell size	A Max	B ^{+0.20}	ØC	ØD ^{+0.2}	E	F	G Max	ØH Max	J Max	K Max	ØL ^{+0.10}	M ^{+0.20}	ØN ^{+0.20}
08	16.50	21.40	3.20	12.00	17.21	16.05	27.65	11.10	27.20	3.00	14.50	21.40	3.60
10	19.50	25.90	3.20	14.97	17.21	16.05	27.65	13.90	32.00	3.00	17.40	25.90	3.60
12	24.00	29.10	3.20	19.05	17.21	16.05	27.65	17.35	35.20	3.00	21.90	29.10	3.60
14	26.90	32.50	3.20	22.22	17.21	16.05	27.65	20.50	38.40	3.00	25.00	32.50	3.60
16	30.30	34.80	3.20	25.40	17.21	16.05	27.65	23.70	41.00	3.00	28.20	34.80	3.60
18	33.70	38.20	3.20	28.57	17.21	16.05	27.65	26.91	44.70	3.00	31.40	38.20	3.60
20	37.00	41.60	3.20	31.77	17.21	15.29	27.65	30.11	47.80	3.00	34.60	41.60	3.60
22	40.40	45.00	3.20	34.90	17.21	15.29	27.65	33.20	51.00	3.00	37.60	45.00	3.60
24	43.40	49.50	3.77	38.10	18.20	15.29	27.65	36.40	55.80	3.00	41.00	49.50	4.10

Specific PC Tail version

Available with layouts using contacts #22D and/or #20
 Also available with clinch nut: please consult us

Specification 571: PC tail length = 4.6 mm

Specification 625: PC tail length = 8.5 mm



Note: All dimensions are in millimeters (mm)



Description

- Available for 8STA & 8TA series
- Special fuel resistant insert: continuous immersion without loss of performance
- Excellent connector sealing on panels by using the jam nut version

Technical specifications

Mechanical

Shell

Aluminium alloy

Shell plating

Conductive black zinc

Insulator

Thermoplastic

Grommet & seal

Fluoroelastomer

Contact

Copper alloy

Contact plating

Gold

Endurance

500 mating cycles

Shock

300g for 3ms and EIA-364-27

Vibration

8STA: 147m/s², 10 to 2000Hz

8TA: random 100 to 1000 Hz - 1G²/Hz

Contact retention

(8TA: Size 22D only)

Size 22D: 45 N

Size 20: 60N

Size 16: 100 N

Size 12: 100 N

Electrical

Test voltage

1300 Vrms

Contact resistance

(8TA: Size 22D only)

Size 22D: 14.6 mΩ

Size 20: 7.3 mΩ

Size 16: 3.8 mΩ

Size 12: 3.5 mΩ

Insulation resistance

≥ 5000 MΩ (at 500 Vdc)

Contact rating

(8TA: Size 22D only)

Size 22D: 5 A

Size 20: 7.5 A

Size 16: 13 A

Size 12: 23 A

Shell continuity

≤10 mΩ

Environmental

Operating temperature

-55°C to +105°C

Sealing mated connectors

IP67 (1 meter for 30 min minimum)

Salt spray

48 hours

Resistance to fluids

Withstands most motorsport fluids

8STA/8TA series fuel immersible

Ordering information

Part numbers

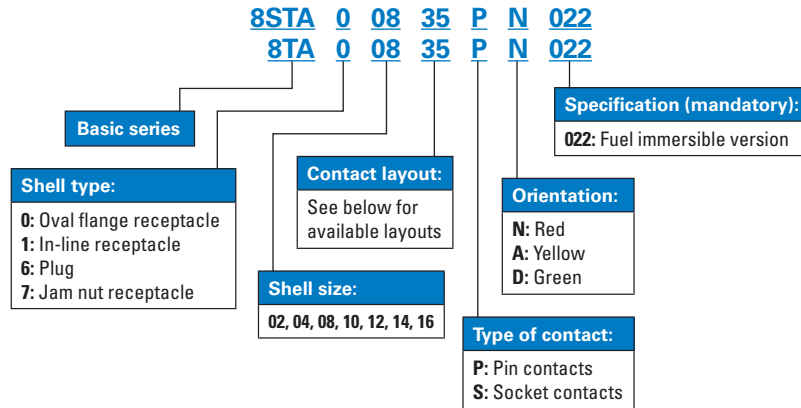

Contact layouts (viewed from front face of male insulator)

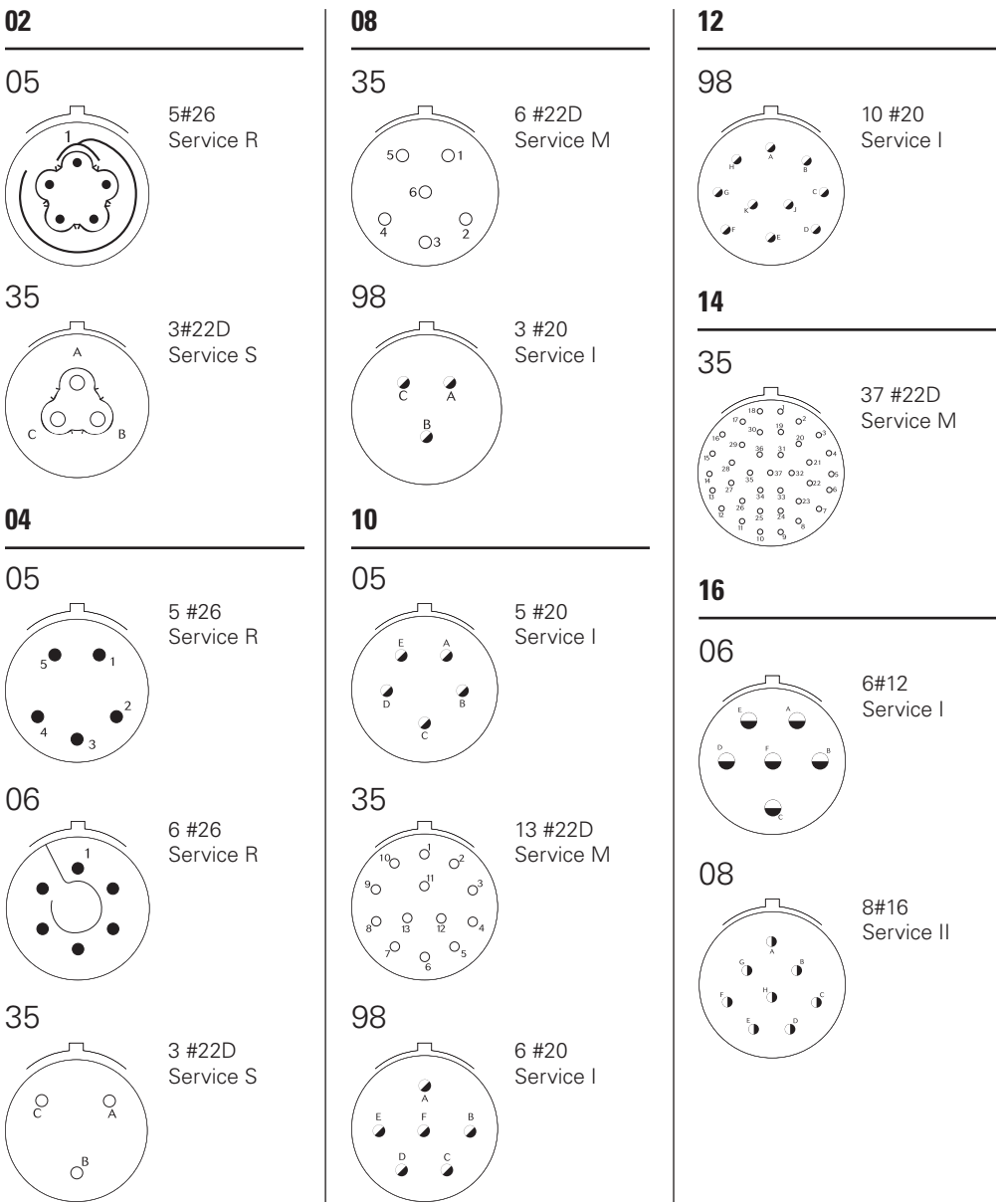



Description

- Rugged aluminium body to ensure long service life in the harshest environment
- Compact low profile
- 6 gold plated #22D contacts
- Environment sealing from interfacial seal and rear grommet
- Positive locking mechanism with locked color indicators 3 keyway orientations
- Not scoop proof
- Conductive black zinc plating

Technical specifications

Mechanical

Shell

Aluminium alloy

Shell plating

Conductive black zinc
Nickel (consult us)

Insulator

Thermoplastic

Grommet & seal

Liquid silicone rubber

Contact

Copper alloy

Contact plating

Gold

Endurance

500 mating cycles

Shock

300g for 3ms and EIA-364-27

Vibration

Random 100 to 1000 Hz - 1 g²/Hz

Contact retention

45 N

Electrical

Test voltage

1300 Vrms sea level)

Contact resistance

<14.6 mΩ

Insulation resistance

≥ 5000 MΩ (at 500 Vdc)

Contact rating

5A

Shell continuity

<60 mΩ

Environmental

Operating temperature

-55°C to +175°C

Sealing mated connectors

IP67 (1 meter for 30 min minimum)

Salt spray

48 hours

8TA series compact low profile

Ordering information

Part numbers

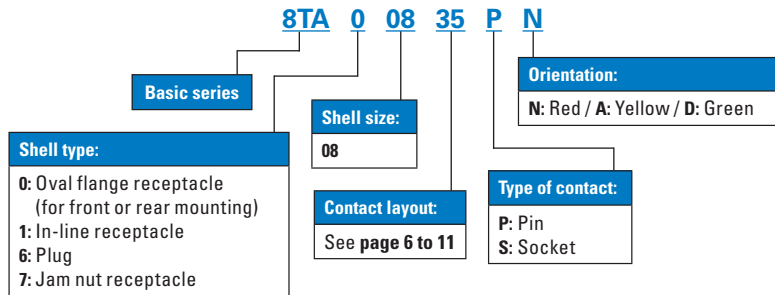

Dimensions

Plug

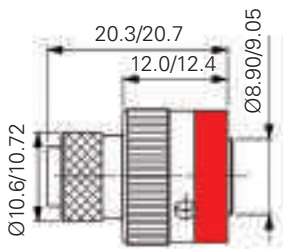

In-line receptacle

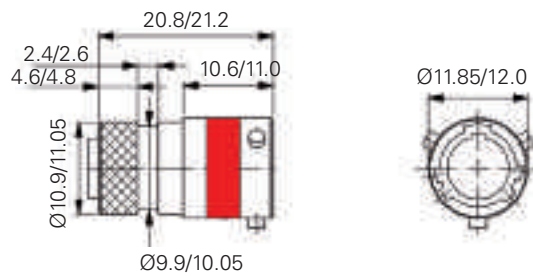

Oval flange receptacle

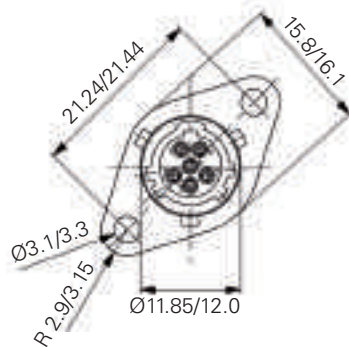
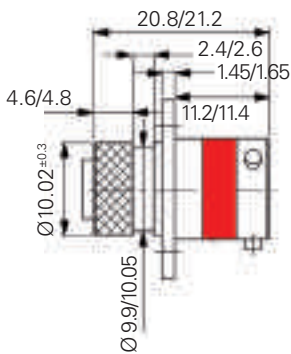

Panel cut out

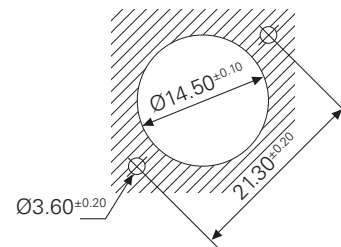

Note: All dimensions are in millimeters (mm)

Jam nut receptacle

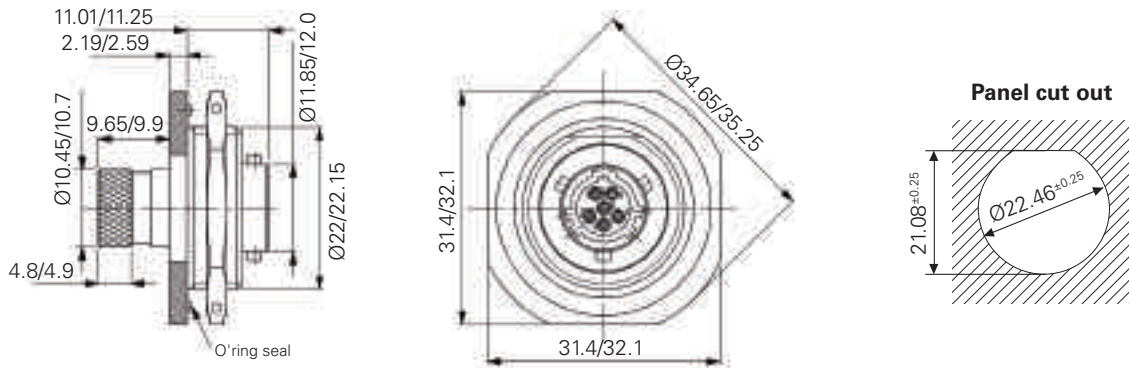

Orientations

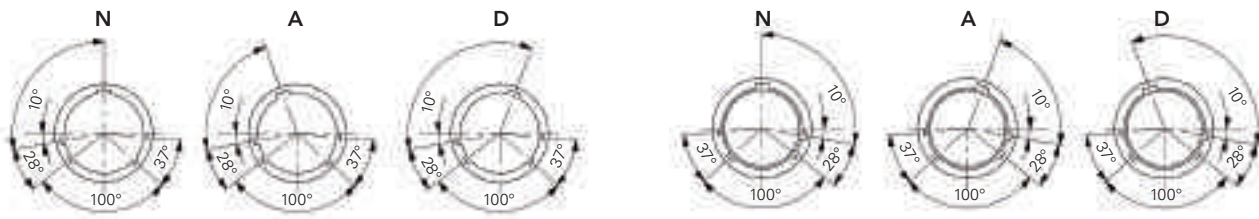

Viewed from front face of receptacle

Viewed from front face of plug

Key positions	Alpha 1	Color band
N	100°	Red
A	82°	Yellow
D	118°	Green

Note: All dimensions are in millimeters (mm)

Contacts

Crimp contacts

Series	Contact size	Shell size & layout	Contact type	Contact Ø max.	Part numbers	Admissible wire section				External Ø over insulation (mm)		
						mm ²		AWG		Min.	Max.	
						Min.	Max.	Min.	Max.	Min.	Max.	
8STA Series	#26 High Density	06-05	Pin	0.50	8593 0998 A	0.055	0.215	30	24	0.60	0.83	
			Socket	0.50	8593 0999 A	0.055	0.215	30	24	0.60	0.83	
		Shell sizes 08 to 24	Pin	0.50	8599-0297	0.055	0.215	30	24	0.60	0.83	
			Socket	0.50	8599-0298	0.055	0.215	30	24	0.60	0.83	
		04-05	Pin	0.50	8593-0947 A	0.055	0.215	30	24	0.60	0.83	
			Socket	0.50	8593-0948 A	0.055	0.215	30	24	0.60	0.83	
		02-05; 04-06; 06-09	Pin	0.50	8599-1001	0.055	0.215	30	24	0.60	0.83	
			Socket	0.50	8599-1002	0.055	0.215	30	24	0.60	0.83	
		01-03; 02-06	Pin	0.50	8599-0297	0.055	0.215	30	24	0.60	0.83	
			Socket	0.50	8593-2516A	0.055	0.215	30	24	0.60	0.83	
		#22D Signal contact	Shell sizes 08 to 24	Pin	0.76	8599-0702 900	0.090	0.380	28	22	0.76	1.37
				Socket	0.76	8599-0706 900	0.090	0.380	28	22	0.76	1.37
	02-35; 04-35; 06-35		Pin	0.76	8599-0702 900	0.090	0.380	28	22	0.71	1.37	
			Socket	0.76	8599-0710 900	0.090	0.380	28	22	0.71	1.37	
	#20 Signal contact	Shell sizes 08 to 24	Pin	1.00	8599-0703 SA	0.215	0.600	24	20	1.02	2.11	
			Socket	1.00	8599-0707 900	0.215	0.600	24	20	1.02	2.11	
	#16 Signal contact	Shell sizes 08 to 24	Pin	1.60	8599-0704 MJ	0.600	1.340	20	16	1.65	2.77	
			Socket	1.60	8599-0708 900	0.600	1.340	20	16	1.65	2.77	
	#16 Coaxial contact	Shell sizes 08 to 24	Pin	1.60	M39029/76 424	RG 174; RG 179; RG 316				1.65	2.60	
			Socket	1.60	M39029/77 428	RG 174; RG 179; RG 316				1.65	2.60	
	#12 Signal contact	Shell sizes 08 to 24	Pin	2.40	8599-0705 MJ	1.910	3.180	14	12	2.46	3.61	
			Socket	2.40	8599-0709 900	1.910	3.180	14	12	2.46	3.61	
	#12 Coaxial contact	Shell sizes 08 to 24	Pin	2.40	M39029/102 558	RG 174; RG 179; RG 316				2.40	2.60	
			Socket	2.40	M39029/103 559	RG 174; RG 179; RG 316				2.40	2.60	
#08 Power contact	Shell sizes 08 to 24	Pin	3.64	8599-7580	-	8.980	-	8	4.50	6.50		
		Socket	3.64	8599-7581	-	8.980	-	8	4.50	6.50		
		Boot	3.64	8599-4542	-	8.980	-	8	4.50	6.50		
		Reductor*	3.64	8599-7645	-	8.980	-	8	4.50	6.50		
#08 Coaxial contact	Shell sizes 08 to 24	Pin	3.64	M39029/59 366	RG 188A/U RG 188A/U RG 188A/U RG 188A/U				-	2.80		
		Socket	3.64	M39029/60 367	RG 188A/U RG 188A/U RG 188A/U RG 188A/U				-	2.80		
		Boot	3.64	8590-4571	RG 188A/U RG 188A/U RG 188A/U RG 188A/U				-	2.80		
#08 Triaxial contact	Shell sizes 08 to 24	Pin	3.64	M39029/90-529	MIL-C17/176 00002; FILECA F2703/14				3.15	3.40		
		Socket	3.64	M39029/91-530	RAYCHEM CHEMINAX 10612;				3.15	3.40		
		Boot	3.64	8590-4571	FILOTEX M 17/176 00002				3.15	3.40		
#04 Power contact (see page 25)	Shell sizes 08 to 24	Pin	5.75	8599-7520A 900	7	10	According to wire used					
		Socket	5.75	8599-7521A 900	7	10	According to wire used					
		Boot	5.75	8599-4593	7	10	According to wire used					
		Reductor**	5.75	8400-2351A	7	10	According to wire used					
		Pin	5.75	8599-7520A 900	4	16	According to wire used					
		Socket	5.75	8599-7521A 900	4	16	According to wire used					
		Boot	5.75	8599-4594	4	16	According to wire used					
8TA Series	#22D Signal contact	08-35	Pin	0.76	8599-0702 900	0.090	0.380	28	22	0.71	1.37	
			Socket	0.76	8599-0710 900	0.090	0.380	28	22	0.71	1.37	
	#20 Signal contact	08-98	Pin	1.00	8599-0703 SA	0.215	0.600	24	20	1.02	2.11	
			Socket	1.00	8599-0711 900	0.215	0.600	24	20	1.02	2.11	

* Reductor must be used for wire 8 mm² ** Reductor must be used for wire 8 & 10 mm²

Note: All dimensions are in millimeters (mm)

PC tail contacts

Contact size	Shell size & layout	Contact type	Contact Ø max.	Part numbers	
#22D	02-35	Pin	0.76	8599 1031 900	
		Socket	0.76	8599 1032 900	
	04-35	Pin	0.76	F1P2P3C0004ALY	
		Socket	0.76	F1P2ES32201A00	
	Shell size 06	Pin	0.76	F1P1P3E0002AJJ	
		Socket	0.76	F1P1ES32202A00	
	Shell sizes 08 to 24	Pin	0.76	F1P1P3E0001ALY	
		Socket	0.76	F1P1ES32201A00	
#26	02-05	Pin	0.50	8593 0949 A	
		Socket	0.50	8593 0950 A	
	04-05	Pin	0.50	8593 0953 A	
		Socket	0.50	8593 0951 A	
	04-06	Pin	0.50	8593 0954 A	
		Socket	0.50	8593 0952 A	
	06-05	Pin	0.50	8593 1000 A	
		Socket	0.50	8593 1001 A	
	Shell sizes 08 to 24	Pin	0.50	8599 0292	
		Socket	0.50	8599 0293	
	#20	Shell sizes 08 to 24	Pin	1.04	F1P1P3E0020ALY
			Socket	1.04	F1P1ES32001A00
#16	Shell sizes 08 to 24	Pin	1.61	F1P1P3E0016ALY	
		Socket	1.61	F1P1ES31601A00	

Wiring instruction

Cable preparation and wire stripping

Contact size	#26							
	Shell size 01	Other shell sizes	#22D	#20	#16	#12	#8	#4
L	3.5	4	4	6	6	6	12	12

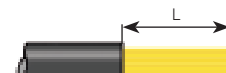

L = length of wire stripping

Insertion of wire in contact barrel

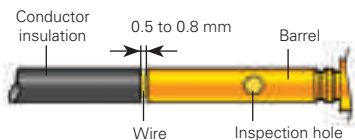

When inserting the stripped wire into the contact barrel check that no strands are left outside and that the wire is visible through the wire inspection hole in the barrel.

Important:

- Slide any accessories over wire strands before carrying out the following operations.
- Contacts are inserted and extracted from the rear of the connector.

Note: All dimensions are in millimeters (mm)

8STA/8TA series

Filler plugs & crimping tools

Filler plugs

These filler plugs are installed at the rear of unwired contacts to maintain connector sealing.

Contact size	MS Part number (Rev. N)	Color	Souriau Part number	Color
#22D	MS27488-22-2	Black	8660-212	Black
#20	MS27488-20-2	Red	8522-389A	Red
#16	MS27488-16-2	Green	8522-390A	Blue
#12	MS27488-12-2	Orange	8522-391A	Yellow

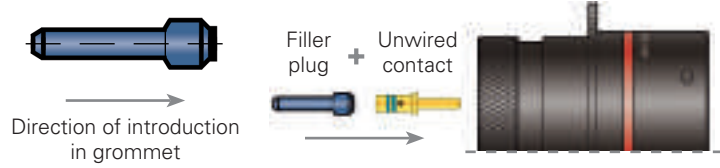

Recommended tooling

Crimp contacts

8STA Series sizes 01, 02, 04, 06 and 8TA Series

Contact size	Contact type	Wire size	Shell size & layout	Locator part number		Tool part number	
				Norm	SOURIAU	Norm	SOURIAU
#22D	Pin	22 to 28	02-35, 04-35, 06-35, 08-35 (8TA only)	M22520/2-09	8476-09	M22520/2-01	8476-01
	Socket	22 to 28	02-35, 04-35, 06-35, 08-35 (8TA only)	M22520/2-06	8476-06	M22520/2-01	8476-01
#26	Pin	24 to 30	06-05	-	8599-0048	M22520/2-01	8476-01
	Socket	24 to 30	06-05	-	8599-0049	M22520/2-01	8476-01
	Pin	24 to 30	04-05	-	8599-0050	M22520/2-01	8476-01
	Socket	24 to 30	04-05	-	8599-0051	M22520/2-01	8476-01
	Pin	24 to 30	02-05, 04-06, 06-09	-	640 088	M22520/2-01	8476-01
	Socket	24 to 30	02-05, 04-06, 06-09	-	640 089	M22520/2-01	8476-01
	Pin	24 to 30	01-03, 02-06	-	8599-0397	M22520/2-01	8476-01
	Socket	24 to 30	01-03, 02-06	-	8593-2556A	M22520/2-01	8476-01

Crimp contacts

8STA Series size 08 to 24

Contact size	Contact type	Plier M22520/1-01		Plier M22520/2-01 (SOURIAU 8476-01)		Plier M300BT		Pneumatic plier M22520/23-01	
		Turret part number	Locator part number	Locator part number	Locator part number	Turret part number	Locator part number	Turret part number	Locator part number
#26	Pin	-	8599-0397	-	-	-	-	-	-
	Socket	-	8599-0398	-	-	-	-	-	-
#22D	Pin	-	M22520/2-09	-	-	-	-	-	-
	Socket	-	M22520/2-06	-	-	-	-	-	-
#20	Pin	M22520/1-04	M22520/2-10	-	-	-	-	-	-
	Socket	M22520/1-04	M22520/2-10	-	-	-	-	-	-
#16	Pin	M22520/1-04	-	-	-	-	-	-	-
	Socket	M22520/1-04	-	-	-	-	-	-	-
#12	Pin	M22520/1-04	-	-	-	-	-	-	-
	Socket	M22520/1-04	-	-	-	-	-	-	-
#8	Pin	-	-	SP 593	M22520/23-02	8599-9601	-	-	-
	Socket	-	-	SP 593	M22520/23-02	8599-9601	-	-	-
#4	Pin	-	-	-	M22520/23-04	M22520/23-11	-	-	-
	Socket	-	-	-	M22520/23-04	M22520/23-11	-	-	-

Insertion and extraction tools

Contact size		Material	Part number		Color	
			Specification	SOURIAU	Insertion	Extraction
#26	Shells 02 to 06	Plastic	-	8599 0444 900	Blue	Red
	Shells 01 & 08 to 24	Plastic	-	8599 0394 900	Black	White
#22D		Plastic	M81969/14-01	-	Green	White
#20		Plastic	M81969/14-10	-	Red	Orange
#16		Plastic	M81969/14-03	-	Blue	White
#12		Plastic	M81969/14-04	-	Yellow	White
#8		Plastic	M81969/14-06	-	-	Red
		Metallic	-	8660 197	-	-
#4		Plastic	M81969/14-07	-	-	Blue
		Metallic	-	8533 8175	-	-



Boots (recommended)

8STA Series

Shell size	Straight boot		90° boot	
	Raychem	Hellerman	Raychem	Hellerman
01	-	1038-4-G	-	1183-4-G
02	203W301-25-G02	1037-4-G	223W601-25	1182-4-G
04	204W221-25-G03	1037-4-G	224W221-25-G03	1182-4-G
06	204W221	1030-4-G	224W221	1181-4-G
08	202K121	152-42-G	222K121	1152-4-G
10	202K132	152-42-G	222K132	1152-4-G
12	202K142	154-42-G	222K142	1154-4-G
14	202K142	155-42-G	222K142	1155-4-G
16	202K153	156-42-G	222K153	1156-4-G
18	202K153	156-42-G	222K153	1156-4-G
20	202K163	157-43-G	222K163	1157-4-G
22	202K163	157-43-G	222K163	1157-4-G
24	202K174	157-43-G	222K174	1157-4-G

8TA Series

Shell size	Straight boot		90° boot	
	Raychem	Hellerman	Raychem	Hellerman
08	202K121	152-42-G	222K121	1152-4-G

Shrinkable termination detail

Shell size	8TA		8STA											
	08	01	02	04	06	08	10	12	14	16	18	20	22	24
ØA	8.65	5.60	7.20	8.65	9.90	10.62	13.72	17.26	20.41	23.6	26.76	29.93	33.11	36.3
ØB ^{±0.15}	8.00	5.05	6.55	8.00	9.25	9.70	12.65	16.02	19.00	22.23	25.22	28.37	31.86	34.67
C ^{±0.15}	2.70	2.20	2.20	2.70	4.20	6.00	6.00	6.00	6.00	6.00	6.00	6.00	6.00	6.00
D	2.30	2.30	2.30	2.30	3.50	3.50	3.50	3.50	3.50	3.50	3.50	3.50	3.50	3.50

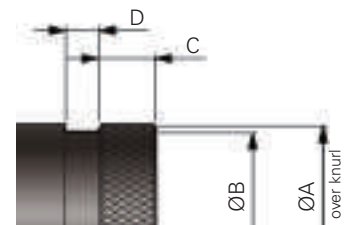

Note: All dimensions are in millimeters (mm)

8STA/8TA series

Metal protective caps

Metal protective caps with lanyard

Plug caps

Cord material: Nylon

Cap plating: Conductive black zinc

Shell size & Layout	Part number	Ø A Max.	B Max.	C ^{±5}
02, except 02-06	8STA802A	10.60	13.20	80
04	8STA804A	12.20	13.80	80
06-05	8STA806A	15.25	15.50	80
06-09, 06-35	8STA806A	15.25	15.50	80
08	8STA808A	17.50	27.44	128
10	8STA810A	20.50	27.44	128
12	8STA812A	24.50	27.44	140
14	8STA814A	27.50	27.44	140
16	8STA816A	30.90	27.44	140
18	8STA818A	34.00	27.44	140
20	8STA820A	37.20	27.44	153
22	8STA822A	40.40	27.44	153
24	8STA824A	43.50	27.44	153

Receptacle caps

Cord material: Nylon

Cap plating: Conductive black zinc

Shell size & Layout	Part number	Ø A Max.	B Max.	C ^{±5}
02, except 02-06	8STA902A	10.60	14.30	80
04	8STA904A	13.60	15.50	80
06-05	8STA906A	15.25	15.50	80
06-09, 06-35	8STA906A	15.25	15.50	80
08	8STA908A	18.90	21	128
10	8STA910A	21.90	21	128
12	8STA912A	26.20	21	140
14	8STA914A	29.40	21	140
16	8STA916A	32.60	22	140
18	8STA918A	35.40	22	140
20	8STA920A	38.90	22	153
22	8STA922A	42.10	22	153
24	8STA924A	45.20	23	153

Size 02 to 06

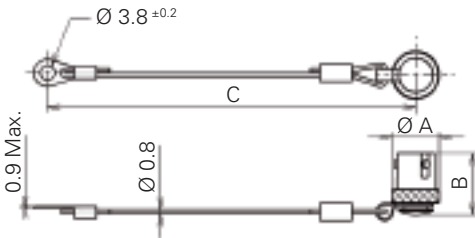

Size 02 to 06

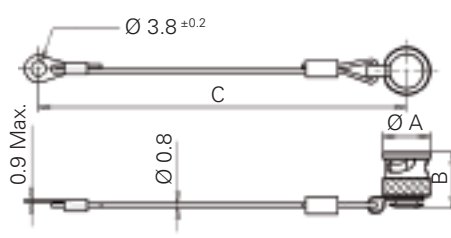

Size 08 to 24

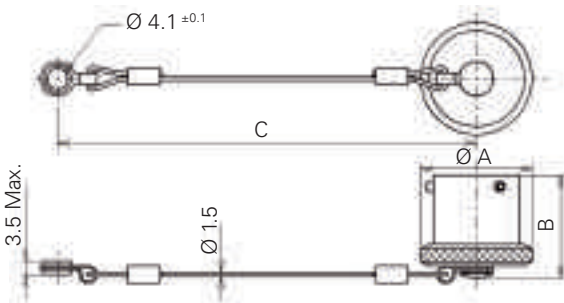

Size 08 to 24

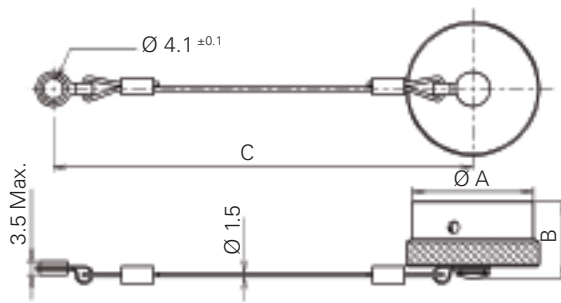

Note: All dimensions are in millimeters (mm)

Metal protective caps without lanyard

Shell size & layout	Part numbers		Dimensions			
	Plug cap	Recep. cap	ØA Max.	B Max.	ØC Max.	D Max.
02, except 02-06	8STA802	8STA902	10.60	11.20	10.60	9.85
04	8STA804	8STA904	12.30	10.80	13.60	10.95
06-05	8STA806	8STA906	15.15	11.05	15.15	9.70
06-09, 06-35	8STA806	8STA906	15.25	11.15	15.15	13.00
08 8TA	8TA808	8TA908	-	-	-	-
8STA	8STA808	8STA908	17.50	21.00	19.00	14.20
10	8STA810	8STA910	20.50	21.00	21.80	14.20
12	8STA812	8STA912	24.50	21.00	26.10	14.20
14	8STA814	8STA914	27.70	21.00	29.30	14.20
16	8STA816	8STA916	30.90	21.00	32.50	15.00
18	8STA818	8STA918	34.00	21.00	35.30	15.00
20	8STA820	8STA920	37.20	21.00	38.80	15.00
22	8STA822	8STA922	40.40	21.00	42.00	15.00
24	8STA824	8STA924	43.50	21.00	45.10	15.85

Plug cap
Type 8

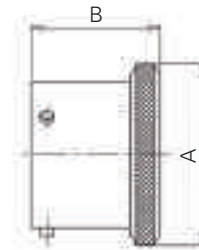

Receptacle cap
Type 9



Nut plates

Nut plates are available for all 8STA sizes. Designed for oval flange receptacles with two holes, specially made for the motorsport market.



Shell size	Self-locking nut thread	Part number
02	M2	8STA-02 M20
02	M2.5	8STA-02 M25
04	M2	8STA-04
04	M2.5	8STA-04 M25
06	M2.5	8STA-06 M25
08	M3	8STA-08
10	M3	8STA-10
12	M3	8STA-12
14	M3	8STA-14
16	M3	8STA-16
18	M3	8STA-18
20	M3	8STA-20
22	M3	8STA-22
24	M3	8STA-24

Gaskets

Gaskets are available for all 8STA sizes. Available in standard version (liquid silicone rubber) and fuel tank version (fluorel).



Shell size	Part number Standard	Part number Fuel tank
02	8STA-G02	8STA-G02 022
04	8STA-G04	8STA-G04 022
06	8STA-G06	8STA-G06 022
08	8STA-G08	8STA-G08 022
10	8STA-G10	8STA-G10 022
12	8STA-G12	8STA-G12 022
14	8STA-G14	8STA-G14 022
16	8STA-G16	8STA-G16 022
18	8STA-G18	8STA-G18 022
20	8STA-G20	8STA-G20 022
22	8STA-G22	8STA-G22 022
24	8STA-G24	8STA-G24 022

Note: All dimensions are in millimeters (mm)



Description

- Crimp removable contacts AWG 24 to 28
- High density layouts from 7 to 104 ways
- High vibration and shock withstanding
- Shell in composite and aluminium: very light and non magnetic

Technical specifications

Mechanical

Shell

Composite (glass fiber reinforced, material for maximum mechanical resistance)
Aluminum

Shell plating

10µ Ni over Cu

Contact

Copper alloy

Contact plating

1.27 µm (50 µin) Au according to Type 2, Grade C of MIL-DTL-45204

Insulator

Thermoplastic

Mounting accessories (clips, jackscrews and jackposts)

Stainless steel, passivated per QQ-P-35

Grommet and seal

Silicone rubber

Drilled bar

Thermoplastic

Endurance/Durability

500 mating/unmating operations

Contact retention in insert

15 N

Vibration

Random: 44g
Sine: 20g

Shock

50g

Electrical

Contact size

#26

Contact pitch

2 mm

Current rating

2.5 Amps

Dielectric withstanding voltage

Sea level: 600 Vrms
70.000 feet: 200 Vrms

Insulation resistance

5,000 MΩ

Low level contact resistance

6 mΩ

Rated current contact resistance

<5 mΩ

Admissible wire gauge

AWG 24 to 28

Shielding effectiveness

> 60dB attenuation
from 1 to 500 MHz

Shell to shell continuity

Composite version: < 2mΩ
Aluminum version: < 2mΩ

Environmental

Operating temperature

-55°C to +175°C

Storage temperature range

-65°C to +125°C

Soldering temperature

+260°C

Salt spray (corrosion)

Composite shell: 2,000 hrs
Aluminum shell: 48 hrs

Flammability

UL 94V-0 (self-extinguishing materials)

RoHS compliant

Product range

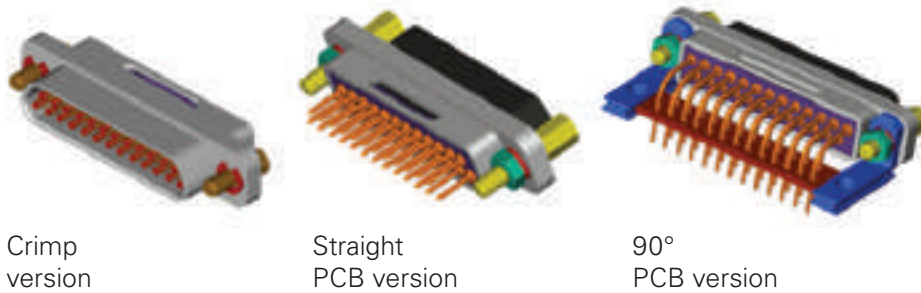

Available layouts

Scale 1:1

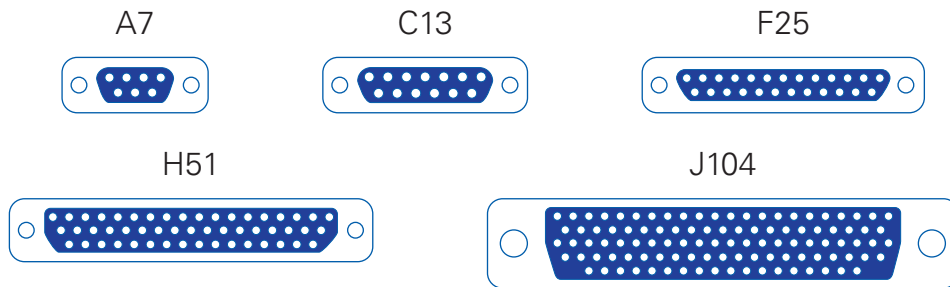

Part numbers

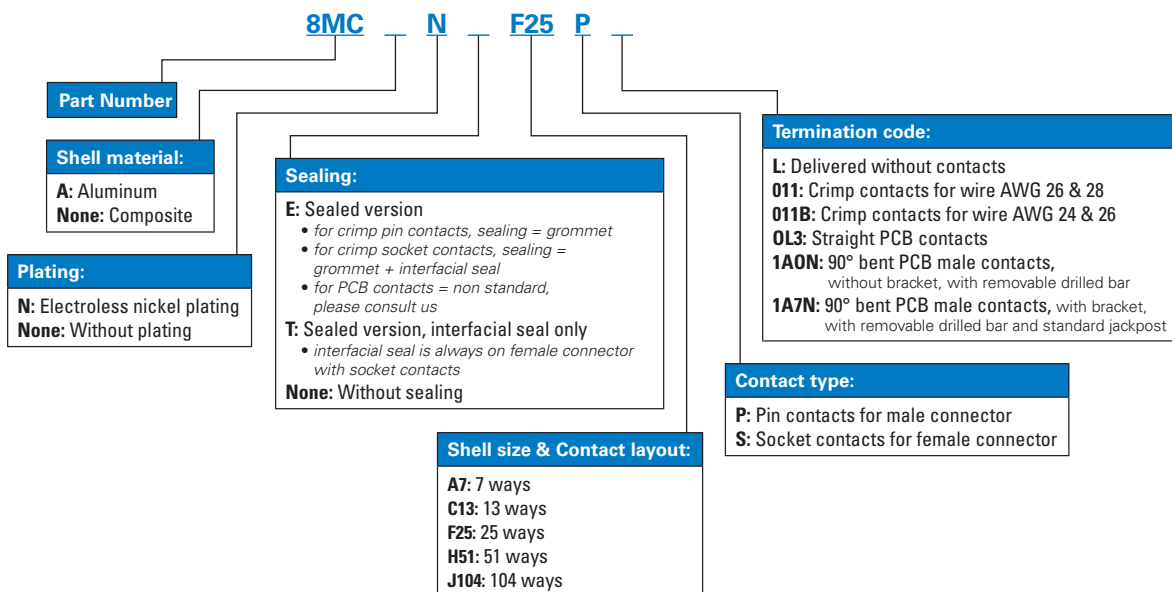

Insertion/extraction tool 8MCIET is always included with -S011, -S011B, -P011B and -P011 versions, but not with -L versions. Termination codes -011, -011B and -L are not marked on the connector (only for order). Jackscrews kits are never included.

For more information, contact us:
eaton.com/interconnect-support



© 2023 Eaton
All Rights Reserved
Document No. TF700-11
March 2023

Eaton is a registered trademark.

All other trademarks are property of
their respective owners.



Phone: (317) 244-6643
Email: usasales@rayfast.com