

BMA Specifications

The specifications below are general specifications for all BMA connectors. Specific specifications for VSWR, insertion loss, and RF leakage for each connector is available from

the factory upon request. Specifications in the following table are recommended for any procurement documents or drawings.

Requirement	Specifications
General	
Material	Steel corrosion resistant per ASTM A-582, 300 Series, AMS 5567, AMS 5370 Brass Alloy per ASTM B-16 Beryllium copper per ASTM B-196 or B-197 PTFE Fluorocarbon per ASTM D-1457 Silicone Rubber per ZZ-R-765, CLASS IIB, 50-60 Shore.
Finish	Center contacts shall be gold plated to a minimum thickness of .00005-inch in accordance with ASTM B-486, Type 2, Code C over nickel underplate. All other metal parts shall be finished so as to provide a connector which meets the corrosion requirements of this table.
Design	The design shall be such that the outline dimensions in this catalog are met. In addition, the assembled connector shall meet the interface dimensions. Dimensions are reference only unless stated.
Electrical	
Insulation Resistance	The insulation resistance shall not be less than 5,000 megaohms.
Dielectric Withstanding Voltage	Refer to applicable military slash sheet or consult factory.
RF High Potential Withstanding Voltage	Refer to applicable military slash sheet or consult factory.
Contact Resistance	Refer to applicable military slash sheet or consult factory.
Voltage Standing Wave Ratio (VSWR)	Refer to applicable military slash sheet or consult factory.
RF Leakage	Refer to applicable military slash sheet or consult factory.
Insertion Loss	Refer to applicable military slash sheet or consult factory.
Corona Level	Refer to applicable military slash sheet or consult factory.
Mechanical	
Force to Engage and Disengage	Engage: 3.0 lbs. Max Disengage: 1.5 lbs. Max.
Misalignment	± .020 Radial Float .060 min. Axial Float
Center Contact Retention	6.0 lbs. Minimum
Cable Retention Force	Refer to applicable military slash sheet or consult factory.
Mating Characteristics	See interface dimensions shown. Applicable to females only: oversize pin .0372 +.0001/-0.000 diameter .030/.045 deep, 3 insertions; insertion force 3 lbs. maximum with .0370 +.0001/-0.000 diameter pin, .050/.075 deep; withdrawal force 1 oz. minimum with .0355 +.0000/-0.001 maximum diameter pin, .050/.075 deep.
Connector Durability	5000 cycles. The connector shall meet the mating characteristic requirements.
Environmental	
Vibration	Specification MIL-STD-202, Method 204, Test Condition D.
Shock	Specification MIL-STD-202, Method 213, Test Condition I.
Thermal Shock	Refer to applicable military slash sheet or consult factory.
Corrosion (Salt Spray)	Specification MIL-STD-202, Method 101, Test Condition B.
Moisture Resistance	Specification MIL-STD-202, Method 106. No measurement at high humidity. Insulation resistance shall be 200 megaohms min. within 5 minutes after removal from humidity.

Complete specifications on every connector in this catalog are available from the factory.

610

BMA male straight panel mount to flex cable

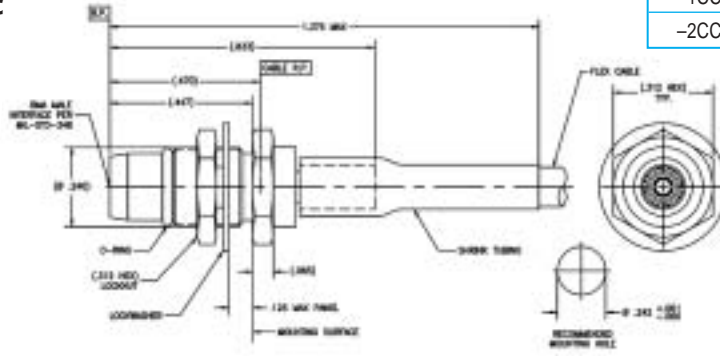

Tensolite Part No	Flex Cable
-1CCSF	RG55, 142, 223, 400, LLF-1141
-2CCSF	RG174, 179, 187, 188, 316, LLF-1087

Center conductor is captivated
SF designates passivated finish

Consult factory for Assembly Instructions

611

BMA male straight panel mount to Semi-Rigid/Semi-Flex cable

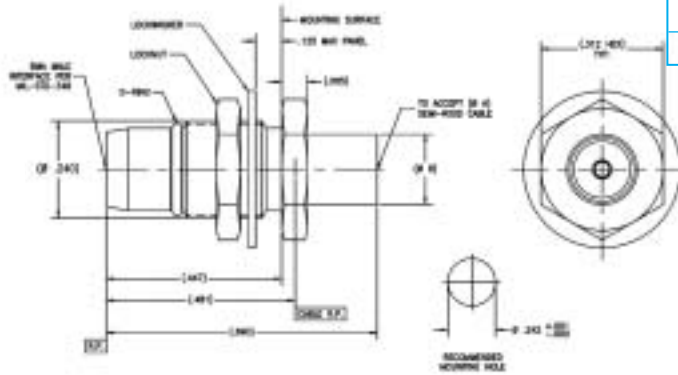

Tensolite Part No	(Ø A)	(ØB)
-1CC	.141	.180
-2CC	.085	.120

Center conductor is captivated
Standard units are gold finish

Consult factory for Assembly Instructions

644

BMA female straight panel float mount to Semi-Rigid/Semi-Flex cable

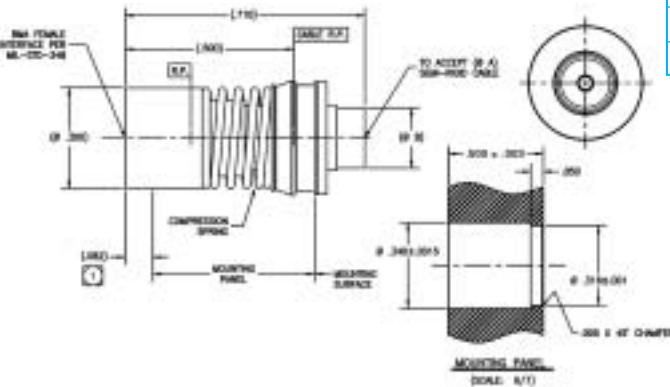

Tensolite Part No	(Ø A)	(ØB)
-1CC	.141	.089 Min
-2CC	.085	.120

Center conductor is captivated
Standard units are gold finish

Consult factory for Assembly Instructions

645

BMA female straight panel float mount to Semi-Rigid/Semi-Flex cable

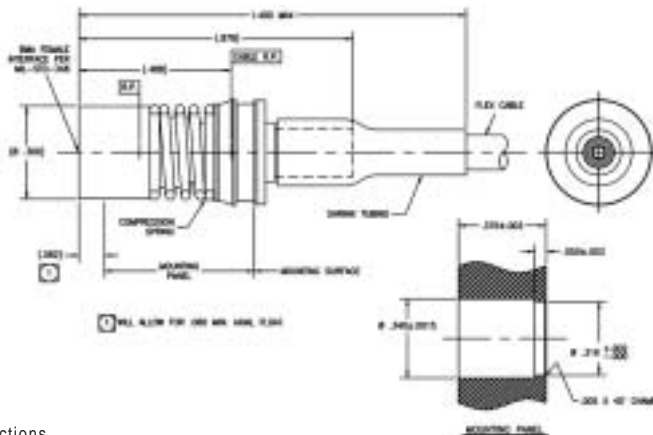

Tensolite Part No	Flex Cable
-1CC	RG55, 142, 233, 400, LLF-1141
-2CC	RG174, 179, 187, 188, 316, LLF-1087

Center conductor is captivated
Standard units are gold finish

Consult factory for Assembly Instructions

BMA Panel Mount

623

BMA female 2 hole flange float mount to Semi-Rigid cable

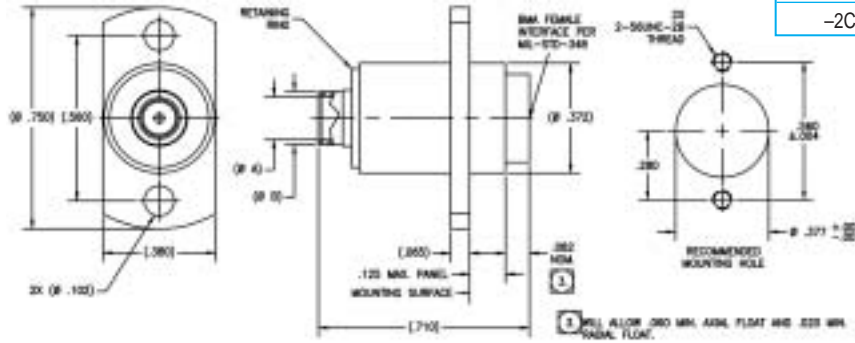

Tensolite Part No	(Ø A)	(ØB)
-1CCSF	.145	.180
-2CCSF	.086	.120

Center conductor is captivated
SF designates passivated finish.

Consult factory for Assembly Instructions

624

BMA female 2 hole flange float mount to flex cable

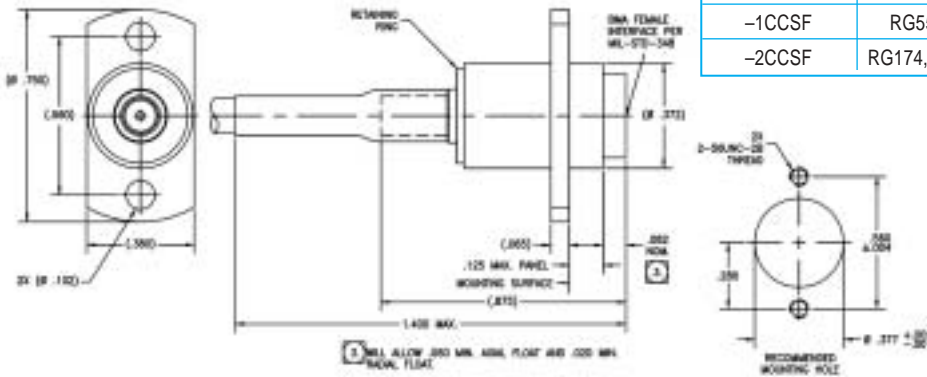

Tensolite Part No	Flex Cable
-1CCSF	RG55, 142, 233, 400
-2CCSF	RG174, 179, 187, 188, 316

Center conductor is captivated
SF designates passivated finish

Consult factory for Assembly Instructions

640

BMA male 2 hole flange (.260 X .625) mount to straight termination

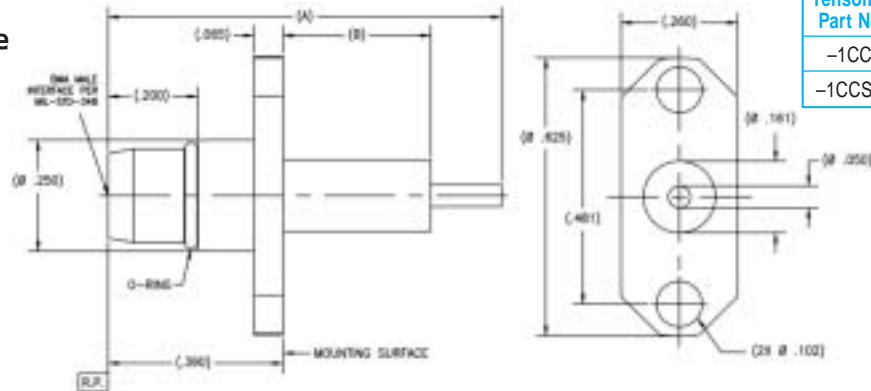

Tensolite Part No	(A)	(B)
-1CC	.878	.330
-1CCSF	.878	.330

Center conductor is captivated
Standard units are gold finish
SF designates passivated finish

641

BMA male 4 hole flange (.500 SQ.) mount to straight termination

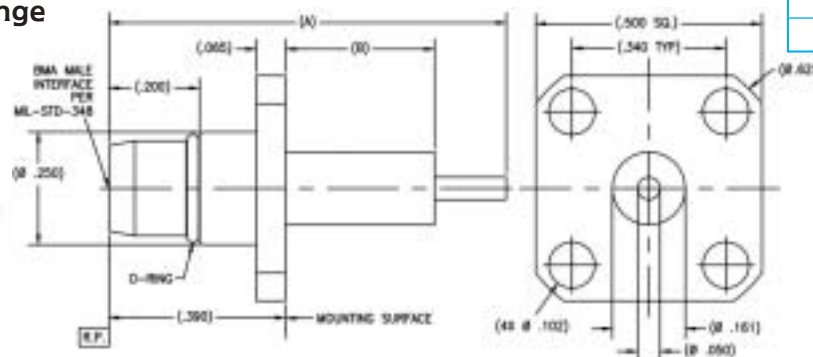

Tensolite Part No	(A)	(B)
-1CC	.878	.330
-1CCSF	.878	.330

Center conductor is captivated
Standard units are gold finish
SF designates passivated finish