

# Series MCX 50 Ω - cable connectors

## Straight cable plugs (male)

For semi-rigid cables, Sucoform and Multiflex cables

- Cable entry soldered
- Centre contact soldered

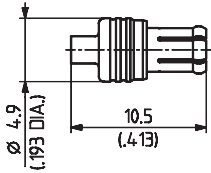

HUBER+SUHNER type	Item no.	Cable group (example)	Packaging	Assembly instruction
11_MCX-50-1-14/111_NE	23032081	Y2, Y15 (EZ_47)	single	27413
11_MCX-50-2-19/111_NE 11_MCX-50-2-19/111_NH	23024699 23032147	Y3, Y11, Y16 (EZ_86)	single bulk 100 pcs.	27496
11_MCX-50-3-1/111_NH	84006763	Y12, Y17 (SUCOFORM_141)	bulk 100 pcs.	0000200108

For flexible cables

- HUBER+SUHNER full crimp
- Taper sleeves see page 554

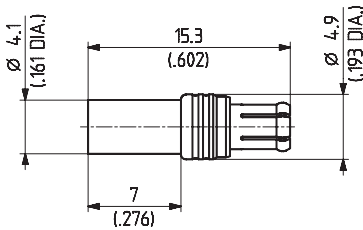

HUBER+SUHNER type	Item no.	Cable group (example)	Packaging	Assembly instruction	Crimp insert
11_MCX-50-1-13/133_NH	22658307	U1 (ENVIROFLEX_178)	bulk 100 pcs.	27316	1 A
11_MCX-50-1-13/111_NH	23002830	U1 (ENVIROFLEX_178)	bulk 100 pcs.	27316	
11_MCX-50-2-15/111_NE 11_MCX-50-2-15/111_NH	84018641 23000440	U4 (ENVIROFLEX_316_D)	single bulk 100 pcs.	27306	
11_MCX-50-2-15/133_NH	23000566	U4 (ENVIROFLEX_316_D)	bulk 100 pcs.	27306	
11_MCX-50-2-16/111_NE 11_MCX-50-2-16/111_NH	84022831 22658275	U2 (ENVIROFLEX_316)	single bulk 100 pcs.	27306	
11_MCX-50-2-16/133_NH	23000437	U2 (ENVIROFLEX_316)	bulk 100 pcs.	27306	

# Series MCX 50 Ω – cable connectors

## Right angle cable plugs (male)

For semi-rigid cables, Sucoform and Multiflex cables

- Cable entry soldered
- Centre contact soldered

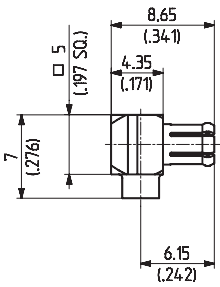

HUBER+SUHNER type	Item no.	Cable group (example)	Packaging	Assembly instruction
16_MCX-50-1-11/111_NE 16_MCX-50-1-11/111_NH	23024700 23032063	Y2, Y15 (EZ_47)	single bulk 100 pcs.	27495
16_MCX-50-2-104/111_NH	23032067	Y3, Y11, Y16 (EZ_86)	bulk 100 pcs.	27308
16_MCX-50-3-8/111_NH	23012471	Y5, Y17 (EZ_141)	bulk 100 pcs.	27401

For flexible cables

- Cable entry crimp
- Centre contact soldered
- Taper sleeves see page 554

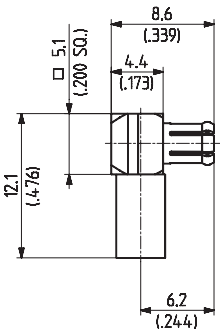

HUBER+SUHNER type	Item no.	Cable group (example)	Packaging	Assembly instruction	Crimp insert
16_MCX-50-1-7/111_NH	23000443	U1 (ENVIROFLEX_178)	bulk 100 pcs.	27319	A
16_MCX-50-1-7/133_NH	22658308	U1 (ENVIROFLEX_178)	bulk 100 pcs.	27319	
16_MCX-50-2-11/133_NE 16_MCX-50-2-11/133_NH	22660003 22650803	U4 (ENVIROFLEX_316_D)	single bulk 100 pcs.	27102	
16_MCX-50-2-11/111_NH-1	23015358	U4 (ENVIROFLEX_316_D)	bulk 100 pcs.	27102	
16_MCX-50-2-14/133_NE 16_MCX-50-2-14/133_NH	22660002 22660001	U2 (ENVIROFLEX_316)	single bulk 100 pcs.	27102	
16_MCX-50-2-14/111_NH	23000445	U2 (ENVIROFLEX_316)	bulk 100 pcs.	27102	

# Series MCX 50 Ω - cable connectors

## Right angle cable plugs (male)

### For flexible cables

- Low profile
- Cable entry soldered
- Centre contact soldered

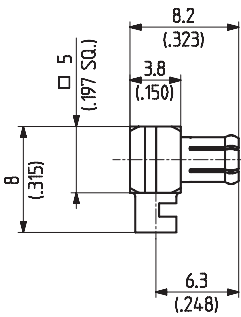

HUBER+SUHNER type	Item no.	Cable group (example)	Packaging	Assembly instruction
16_MCX-50-2-102/111_NH-1	23000454	U2 (ENVIROFLEX_316)	bulk 100 pcs.	27307

## Straight cable jacks (female)

### For flexible cables

- HUBER+SUHNER full crimp
- Taper sleeves see page 554

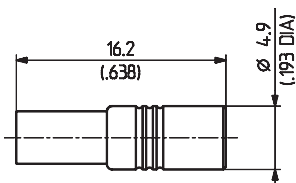

HUBER+SUHNER type	Item no.	Cable group (example)	Packaging	Assembly instruction	Crimp insert
21_MCX-50-1-11/111_NE 21_MCX-50-1-11/111_NH	84023972 23005297	U1 (ENVIROFLEX_178)	single bulk 100 pcs.	27317	1 A
21_MCX-50-2-12/111_NE	23032052	U4 (ENVIROFLEX_316_D)	single	27309	
21_MCX-50-2-12/133_NH	22658278	U4 (ENVIROFLEX_316_D)	bulk 100 pcs.	27309	
21_MCX-50-2-13/111_NH	23005298	U2 (ENVIROFLEX_316)	bulk 100 pcs.	27309	
21_MCX-50-2-13/133_NH	22658279	U2 (ENVIROFLEX_316)	bulk 100 pcs.	27309	

# Series MCX 50 Ω – cable connectors

## Straight bulkhead cable jacks (female)

For semi-rigid, Sucoform and Multiflex cables

- Cable entry soldered
- Centre contact soldered

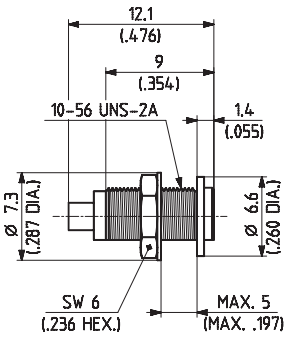

Fig. 1

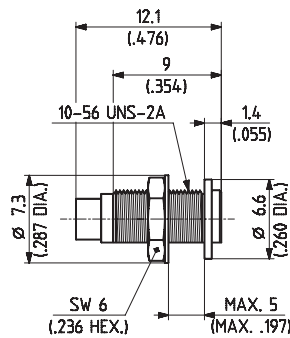
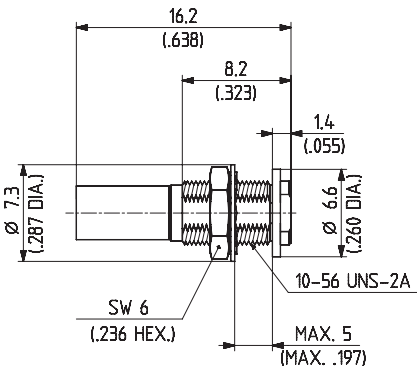

Fig. 2

HUBER+SUHNER type	Item no.	Cable group (example)	Packaging	Assembly instruction	Mounting hole	Fig.
24_MCX-50-1-3/111_NE	22641648	Y2, Y15 (EZ_47)	single	3100	ML 11	1
24_MCX-50-2-3/111_NE	22543580	Y3, Y11 (EZ_86)				2

For flexible cables

- HUBER+SUHNER full crimp
- Taper sleeves see page 554



HUBER+SUHNER type	Item no.	Cable group (example)	Packaging	Assembly instruction	Mounting hole	Crimp insert
24_MCX-50-1-13/111_NH	23005299	U1 (ENVIROFLEX_178)	bulk 100 pcs.	27317	ML 11	1 A
24_MCX-50-1-13/133_NH	22658310	U1 (ENVIROFLEX_178)		27317		
24_MCX-50-2-6/111_NH	23005300	U4 (ENVIROFLEX_316_D)		27309		
24_MCX-50-2-7/111_NH	23000468	U2 (ENVIROFLEX_316)		27309		

# Series MCX 50 Ω - receptacles with solder end

## Receptacles, jacks (female)

- Bulkhead mounted
- Front mounting

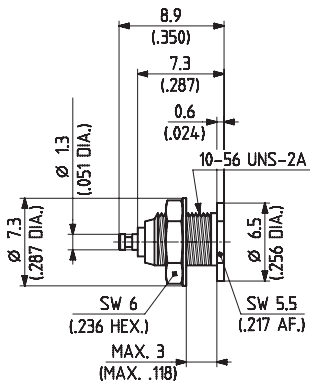

Fig. 1

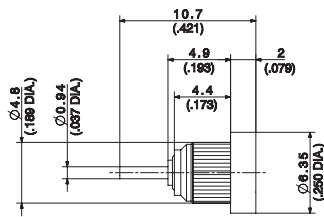

Fig. 2 (press-in)

HUBER+SUHNER type	Item no.	Packaging	Mounting hole	Fig.
22_MCX-50-0-2/111_NE	22640171	single	ML 11	1
22_MCX-50-0-2/111_NH	22646960	bulk 100 pcs.	ML 11	
22_MCX-50-0-2/133_NH	22644433	bulk 100 pcs.	ML 11	2
22_MCX-50-0-19/111_NH	22652984	bulk 100 pcs.	ML 103	

# Series MCX 50 Ω – PCB connectors

## Straight PCB plugs (male)

- With stand-off
- 2.54 mm/0.100 in. grid

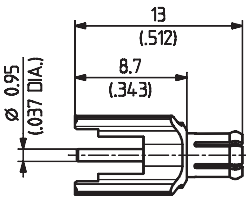

Fig. 1

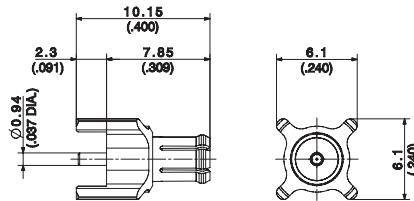

Fig. 2

HUBER+SUHNER type	Item no.	Packaging	Mounting hole	Fig.
81_MCX-50-0-6/111_NE	84023713	single	ML 15	1
81_MCX-50-0-6/111_NH	23005296	bulk 100 pcs.		
81_MCX-50-0-9/111_NH	23026871	bulk 100 pcs.		2

## Straight PCB jacks (female)

- 2.54 mm/0.100 in. grid

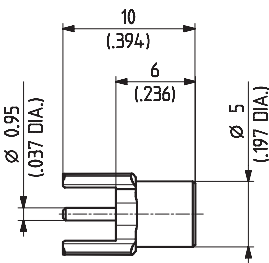

Fig. 1

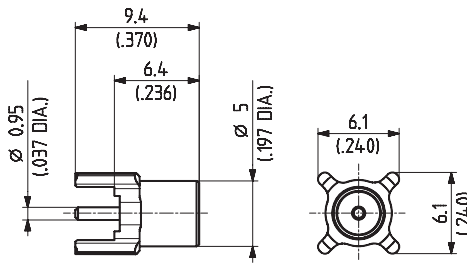

Fig. 2

HUBER+SUHNER type	Item no.	Packaging	Mounting hole	Notes	Fig.
82_MCX-50-0-17/111_NH-1	23006209	bulk 100 pcs.	ML 15	without stand-off	1
82_MCX-50-0-19/111_NE	84018352	single		with stand-off	
82_MCX-50-0-19/111_NH-1	22658305	bulk 100 pcs.			2
82_MCX-50-0-19/111_NM	23000573	tape and reel			

# Series MCX 50 Ω – PCB connectors

## Straight PCB jacks (female)

- 1.27 mm/0.050 in. grid
- Space saving version

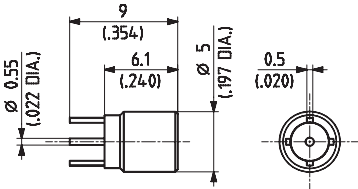

HUBER+SUHNER type	Item no.	Packaging	Mounting hole	Notes
82_MCX-50-0-10/111_NE	22641649	single	ML 44	without stand-off
82_MCX-50-0-10/111_NH	22651980	bulk 100 pcs.		

- Surface mount type SMT

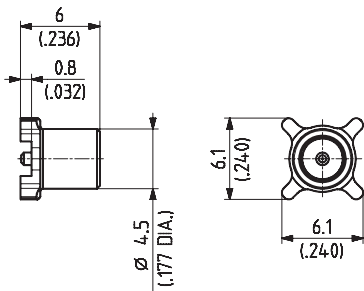

HUBER+SUHNER type	Item no.	Packaging	Mounting hole
82_MCX-S50-0-29/111_NE	84018482	single	ML 120
82_MCX-S50-0-29/111_NH	23001527	bulk 100 pcs.	
82_MCX-S50-0-29/111_NM	22658306	tape and reel	

- Surface mount type SMT
- Edge mount

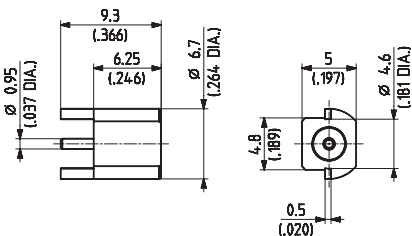

HUBER+SUHNER type	Item no.	Packaging	Mounting hole
82_MCX-S50-0-22/111_NE	22651467	single	ML 121
82_MCX-S50-0-22/111_NM	84011207	tape and reel	

# Series MCX 50 Ω – PCB connectors

## Right angle PCB jacks (female)

- 2.54 mm/0.100 in. grid

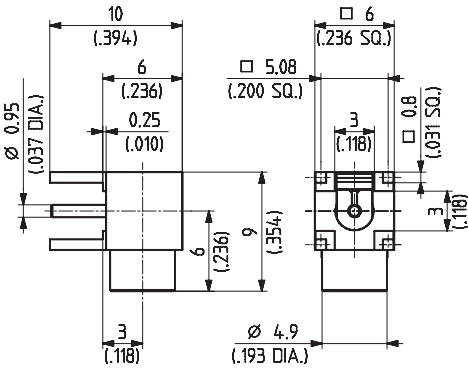
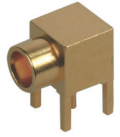

HUBER+SUHNER type	Item no.	Packaging	Mounting hole
85_MCX-50-0-16/111_NE	84018523	single	ML 15
85_MCX-50-0-16/111_NH	23001545	bulk 100 pcs.	
85_MCX-50-0-16/111_NM	84030779	tape and reel	

- Surface mount type SMT

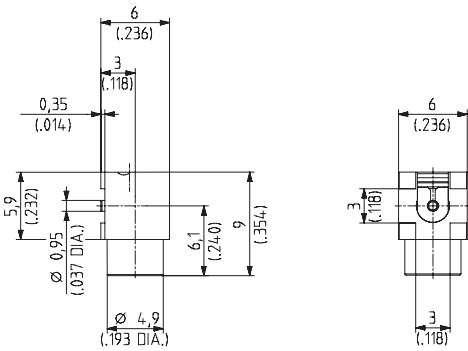

HUBER+SUHNER type	Item no.	Packaging	Mounting hole
85_MCX-S50-0-25/111_NH	23005091	bulk 100 pcs.	ML 123
85_MCX-S50-0-25/111_NM	84036471	tape and reel	