

# Series MMCX – cable connectors

## Straight cable plugs (male)

### For semi-rigid cables

- Cable entry soldered
- Centre contact crimped

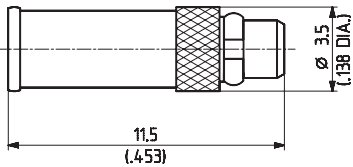

HUBER+SUHNER type	Item no.	Cable group (example)	Packaging	Assembly instruction	Crimp insert
11_MMCX-50-1-3/111_OE	22648893	Y2 (EZ_47)	single	9078	1
11_MMCX-50-2-1/111_OE	22645297	Y3, Y11, Y16 (EZ_86)	single bulk 100 pcs.	9170	
11_MMCX-50-2-1/111_OH	22649039				

### For flexible cables

- HUBER+SUHNER full crimp

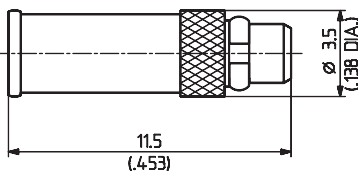

HUBER+SUHNER type	Item no.	Cable group (example)	Packaging	Assembly instruction	Crimp insert
11_MMCX-50-1-1/111_OE	22645298	U1 (ENVIROFLEX_178)	single bulk 100 pcs.	9169	1/2.67
11_MMCX-50-1-1/111_OH	22651666				
11_MMCX-50-1-2/111_OE	22645296	U0 (K_01152-07)	single bulk 100 pcs.		
11_MMCX-50-1-2/111_OH	84027753				

### For flexible cables

- HUBER+SUHNER full crimp

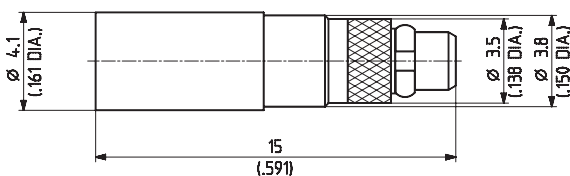

HUBER+SUHNER type	Item no.	Cable group (example)	Packaging	Assembly instruction	Crimp insert
11_MMCX-50-2-3/111_OE	22649899	U2 (ENVIROFLEX_316)	single bulk 100 pcs.	9110	1 A
11_MMCX-50-2-3/111_OH	23000258				
11_MMCX-50-2-4/111_OE	22649901	U4 (ENVIROFLEX_316_D)	single		

Cable groups see page 32      Assembly tools see page 531      Mounting holes/PCB layouts see page 561

# Series MMCX – cable connectors

## Right angle cable plugs (male)

### For semi-rigid cables

- Cable entry soldered
- Centre contact soldered

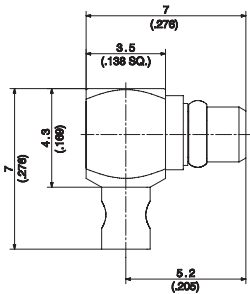

Fig. 1

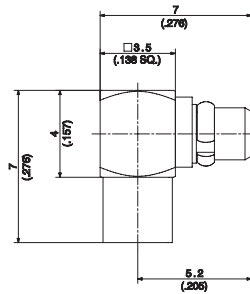

Fig. 2



HUBER+SUHNER type	Item no.	Cable group (example)	Packaging	Assembly instruction	Fig.
16_MMCX-50-1-12/111_OE 16_MMCX-50-1-12/111_OH	84030531 21000178	Y2, Y15 (EZ_47)	single bulk 100 pcs.	0000180777	1
16_MMCX-50-2-13/111_OE 16_MMCX-50-2-13/111_OH	84032569 84007944	Y3, Y11 (EZ_86)	single bulk 100 pcs.	0000214734	2

### For flexible cables

- Cable entry crimp
- Centre contact soldered

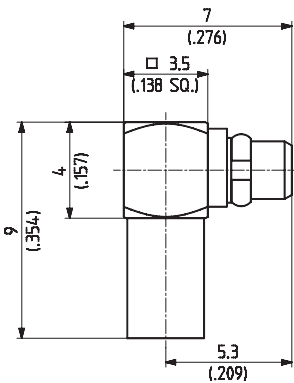

HUBER+SUHNER type	Item no.	Cable group (example)	Packaging	Assembly instruction	Crimp insert
16_MMCX-50-1-1/111_OE 16_MMCX-50-1-1/111_OH	22645955 22648762	U1 (ENVIROFLEX_178)	single bulk 100 pcs.	9175	2.67

# Series MMCX – cable connectors

## Right angle cable plugs (male)

### For flexible cables

- Cable entry crimp
- Centre contact soldered

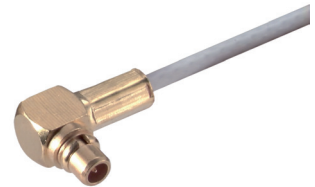
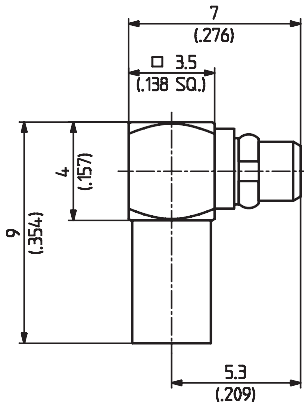

HUBER+SUHNER type	Item no.	Cable group (example)	Packaging	Assembly instruction	Crimp insert
16_MMCX-50-1-2/111_OE 16_MMCX-50-1-2/111_OH	22645956 22649009	U0 (K_01152-07)	single bulk 100 pcs.	9175	2.67

### For flexible cables

- Cable entry crimp
- Centre contact soldered

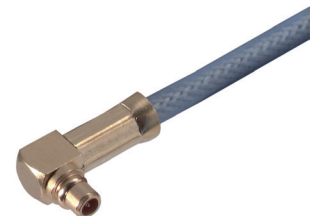
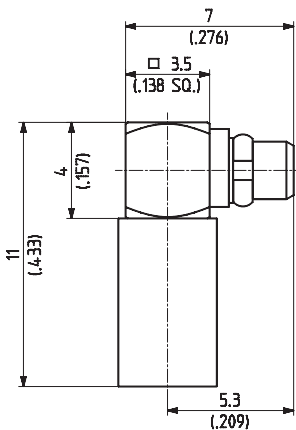

HUBER+SUHNER type	Item no.	Cable group (example)	Packaging	Assembly instruction	Crimp insert
16_MMCX-50-2-2/111_OE 16_MMCX-50-2-2/111_OH	22649374 22651401	U4 (ENVIROFLEX_316_D)	single bulk 100 pcs.	9128	A
16_MMCX-50-2-4/111_OE 16_MMCX-50-2-4/111_OH	22649433 22649635	U2 (ENVIROFLEX_316)	single bulk 100 pcs.		

# Series MMCX – cable connectors

## Straight cable jacks (female)

### For semi-rigid cables

- Cable entry soldered
- Centre contact crimped

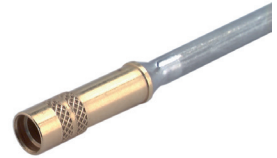
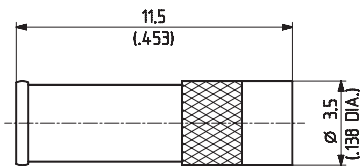

HUBER+SUHNER type	Item no.	Cable group (example)	Packaging	Assembly instruction	Crimp insert
21_MMCX-50-2-1/111_OE	22645290	Y3, Y11, Y16 (EZ_86)	single	9170	1

### For flexible cables

- HUBER+SUHNER full crimp

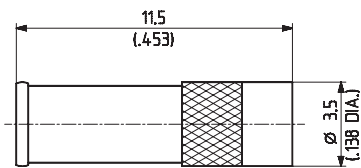

HUBER+SUHNER type	Item no.	Cable group (example)	Packaging	Assembly instruction	Crimp insert
21_MMCX-50-1-1/111_OE	22645288	U1 (ENVIROFLEX_178)	single	9169	1/2.67
21_MMCX-50-1-2/111_OE	22645289	U0 (K_01152-07)			

## Straight bulkhead cable jacks (female)

### For semi-rigid cables

- Cable entry soldered
- Centre contact crimped
- Front mounting

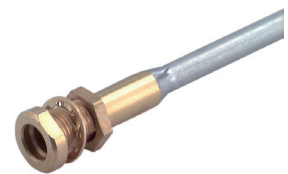
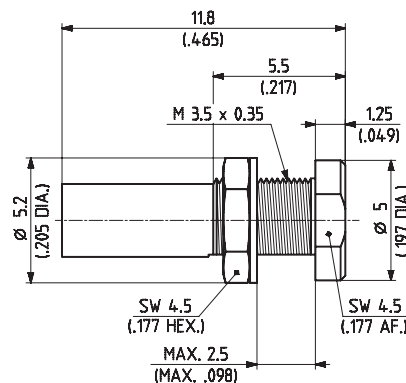

HUBER+SUHNER type	Item no.	Cable group (example)	Packaging	Assembly instruction	Mounting hole	Crimp insert
24_MMCX-50-2-1/111_OE	22645954	Y3, Y11, Y16 (EZ_86)	single	9170	ML68	1

# Series MMCX – cable connectors

## Straight bulkhead cable jacks (female)

### For flexible cables

- HUBER+SUHNER full crimp
- Front mounting

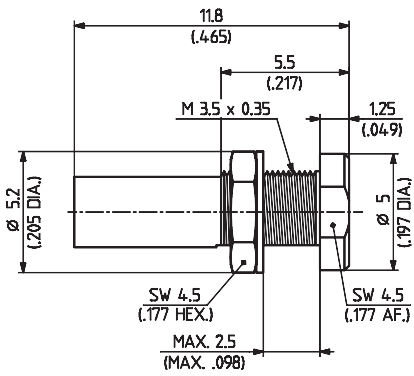

HUBER+SUHNER type	Item no.	Cable group (example)	Packaging	Assembly instruction	Mounting hole	Crimp insert
24_MMCX-50-1-1/111_OE	22645952	U1 (ENVIROFLEX_178)	single	9169	ML68	1/2.67
24_MMCX-50-1-1/111_OH	23000416		bulk 100 pcs.			

# Series MMCX – receptacles with solder end

## Receptacles, jacks (female)

- Bulkhead mounted

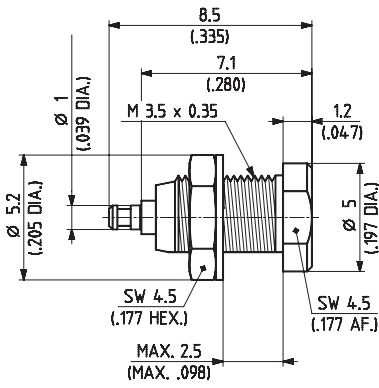

HUBER+SUHNER type	Item no.	Packaging	Mounting hole
22_MMCX-50-0-1/111_OE	22645951	single	ML 68
22_MMCX-50-0-1/111_OH	22660126	bulk 100 pcs.	

- Bulkhead mounted

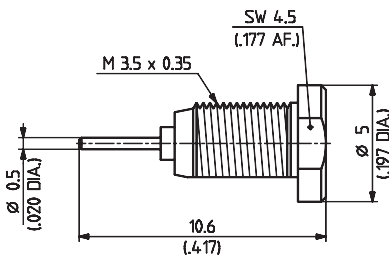

HUBER+SUHNER type	Item no.	Packaging	Mounting hole
22_MMCX-50-0-4/111_OH	22660282	bulk 100 pcs.	M 3.5 × 0.35

# Series MMCX – PCB connectors

## Straight PCB plugs (male)

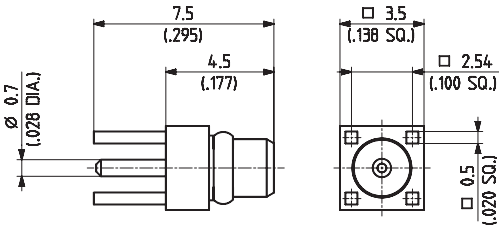
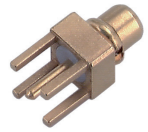

HUBER+SUHNER type	Item no.	Packaging	Mounting hole	Notes
81_MMCX-50-1-1/111_OE	22646298	single	ML 44	without stand-off

## Straight PCB jacks (female)

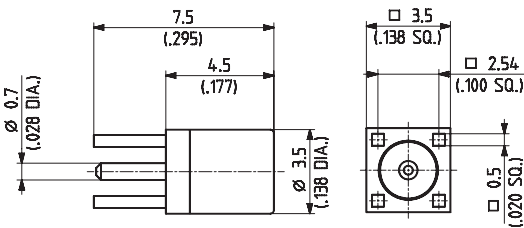

HUBER+SUHNER type	Item no.	Packaging	Mounting hole	Notes
82_MMCX-50-0-1/111_NE	22645958	single	ML 44	without stand-off
82_MMCX-50-0-1/111_NH	22648469	bulk 100 pcs.		

## Jacks for horizontal applications

- Edge mount

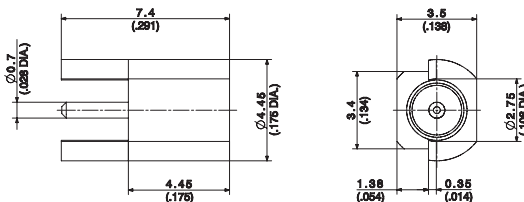
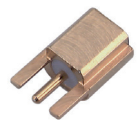

HUBER+SUHNER type	Item no.	Packaging	PCB layout	Notes
82_MMCX-S50-0-2/111_KE	22648789	single	see application notes on page 125	
82_MMCX-S50-0-2/111_KH	22649680	bulk 100 pcs.	see application notes on page 125	
82_MMCX-S50-0-2/111_KG	22649679	tape and reel	see application notes on page 125	blister tape containing 750 pcs.

# Series MMCX – PCB connectors

## Straight PCB jacks (female)

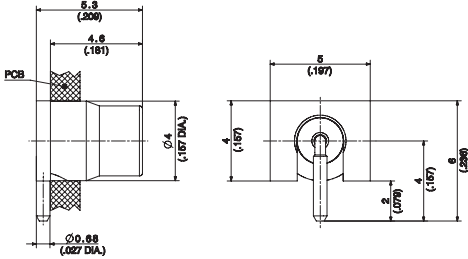

Fig. 1

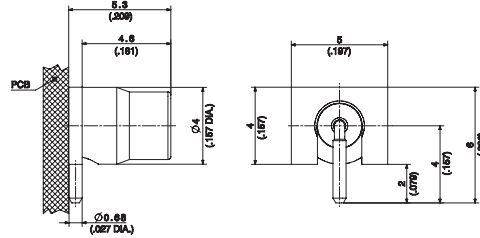
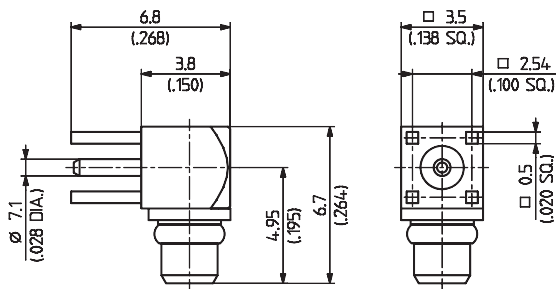

Fig. 2



HUBER+SUHNER type	Item no.	Packaging	Mounting hole	Notes	
82_MMCX-50-0-8/111_OE	22652153	single	ML 167	through-hole mount	1
82_MMCX-50-0-8/111_OM	22660270	tape and reel			
82_MMCX-50-0-18/111_OM	23023564	tape and reel	ML 130	surface mount technology	2

## Right angle PCB plugs (male)



HUBER+SUHNER type	Item no.	Packaging	Mounting hole	Notes
84_MMCX-50-0-1/111_OH	22658819	bulk 100 pcs.	ML 44	without stand-off

## Right angle PCB jacks (female)

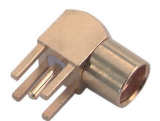
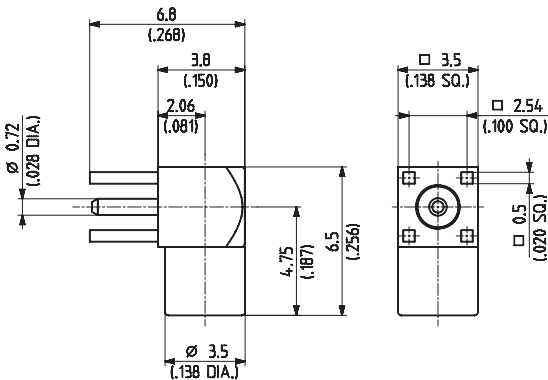

HUBER+SUHNER type	Item no.	Packaging	Mounting hole	Notes
85_MMCX-50-0-1/111_OE	22645968	single	ML 44	without stand-off
85_MMCX-50-0-1/111_OH	22646636	bulk 100 pcs.		