

# Series QLA 00 – cable connectors

## Straight cable plugs (male)

### For flexible cables

- HUBER+SUHNER full crimp

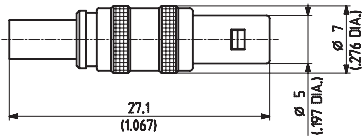

HUBER+SUHNER type	Item no.	Cable group (example)	Packaging	Assembly instruction	Crimp insert
11_QLA-01-1-8/122_NE	22641146	U1 (RG_178_B/U, ENVIROFLEX_178)	single	9007	1 A
11_QLA-01-2-8/122_NE 11_QLA-01-2-8/122_NH	22544043 22544042	U2 (RG_316_/U, ENVIROFLEX_316)	single bulk 100 pcs.		
11_QLA-01-2-9/122_NH	22648228	U4 (K_02252_D, ENVIROFLEX_316_D)	bulk 100 pcs.		
11_QLA-01-2-13/122_NH	22644547	U3 (G_01130_HT)	bulk 100 pcs.	27020	

### For flexible cables

- HUBER+SUHNER full crimp

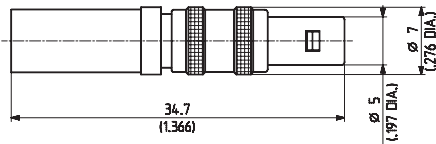

HUBER+SUHNER type	Item no.	Cable group (example)	Packaging	Assembly instruction	Crimp insert
11_QLA-01-3-1/122_NE	22641313	U7 (RG_58_C/U, ENVIROFLEX_B58)	single	3015	2 B
11_QLA-01-3-2/122_NE	22643326	U9 (RG_223_/U, ENVIROFLEX_B223)			

# Series QLA 00 – cable connectors

## Right angle cable plugs (male)

### For flexible cables

- Cable entry crimp
- Centre contact soldered

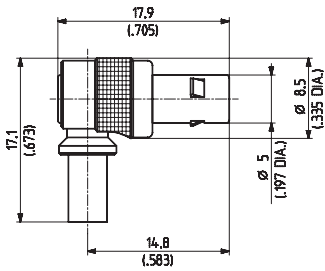

HUBER+SUHNER type	Item no.	Cable group (example)	Packaging	Assembly instruction	Crimp insert
16_QLA-01-2-1/122_NE	22640013	U2 (RG_316_/U, ENVIROFLEX_316)	single	3091	A
16_QLA-01-2-13/122_NE	22544279	U3 (G_01130_HT)			

## Straight cable jack (female)

### For flexible cables

- HUBER+SUHNER full crimp

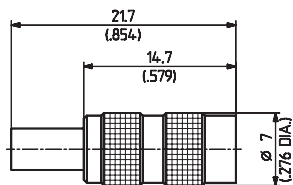

HUBER+SUHNER type	Item no.	Cable group (example)	Packaging	Assembly instruction	Crimp insert
21_QLA-01-2-5/112_NH	22652371	U2 (RG_316_/U, ENVIROFLEX_316)	bulk 100 pcs.	27158	1 A

# Series QLA 00 – cable connectors

## Straight bulkhead cable jacks (female)

### For flexible cables

- Cable entry crimp
- Centre contact soldered

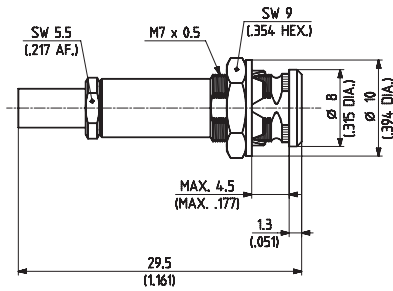

HUBER+SUHNER type	Item no.	Cable group (example)	Packaging	Assembly instruction	Mounting hole	Crimp insert
24_QLA-01-2-1/112_NE	22640026	U2 (RG_316_/U, ENVIROFLEX_316)	single	3089	ML 99	A

# Series QLA 00 – receptacles with solder end

## Receptacles, jacks (female)

- Bulkhead mounted

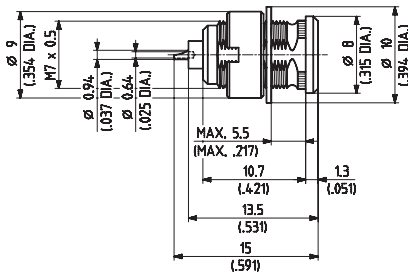

Fig. 1

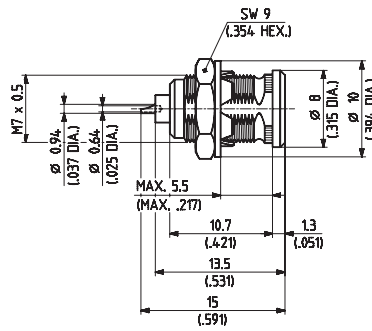

Fig. 2



HUBER+SUHNER type	Item no.	Packaging	Mounting hole	Fig.	Notes
22_QLA-01-0-1/112_NE	22640023	single	ML 23	1	
22_QLA-01-0-1/112_NH	22646308	bulk 100 pcs.	ML 23	1	
22_QLA-01-0-2/112_NE	22640024	single	ML 99	2	counter sunk from rear

# Series QLA 00 – PCB connectors

## Straight PCB jack (female)

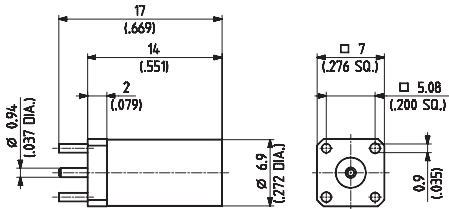

HUBER+SUHNER type	Item no.	Packaging	Mounting hole	Notes
82_QLA-01-0-2/112_NE	22543414	single	ML 97	without stand-off

## Right angle PCB jacks (female)

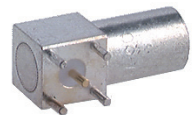
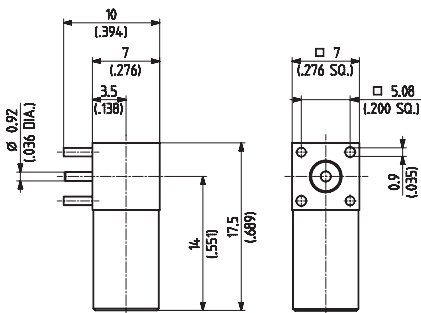

HUBER+SUHNER type	Item no.	Packaging	Mounting hole	Notes
85_QLA-01-0-2/112_NE	22640039	single	ML 97	without stand-off
85_QLA-01-0-2/110_NH	22646483	bulk 100 pcs.		