

Series QMA – cable connectors

Straight cable plugs (male)

For semi-rigid, Sucoform and Multiflex cables

- Cable entry soldered
- Centre contact plugged-in

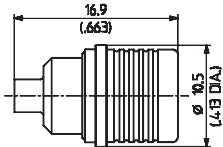

HUBER+SUHNER type	Item no.	Cable group (example)	Packaging	Assembly instruction
11_QMA-50-2-3/133_NE	23017704	Y3, Y11, Y16	single	27428
11_QMA-50-2-3/133_NH	23017705	{SUCOFORM_86, EZ_86}	bulk 100 pcs.	

For semi-rigid, Sucoform and Multiflex cables

- Cable entry soldered
- Centre contact plugged-in

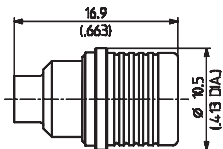

HUBER+SUHNER type	Item no.	Cable group (example)	Packaging	Assembly instruction	Notes
11_QMA-50-3-3/133_NE	23017695	Y5, Y12, Y17 {SUCOFORM_141},	single	27428	body: SUCOPRO®
11_QMA-50-3-3/133_NH	23017696	EZ_141	bulk 100 pcs.		gold plating

Series QMA – cable connectors

Straight cable plugs (male)

For semi-rigid, Sucoform and Multiflex cables

- Waterproof
- Cable entry soldered
- Centre contact plugged or soldered

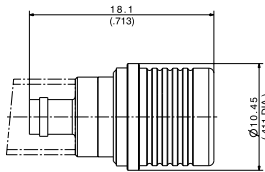

Fig. 1

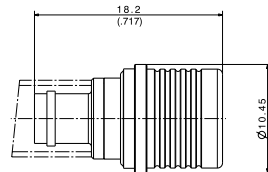
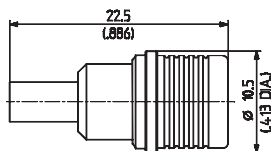

Fig. 2

HUBER+SUHNER type	Item no.	Cable group (example)	Packaging	Assembly instruction	Fig.	Notes
11_QMA-W50-2-6/113_NH	84068215	Y3, Y11, Y16 (SUCOFORM_86, EZ_86)	bulk 100 pcs.	0000263508	1	
11_QMA-W50-3-7/113_NE 11_QMA-W50-3-7/113_NH	84075868 84068217	Y5, Y12, Y17 (SUCOFORM_141, EZ_141)	single bulk 100 pcs.	0000263762	2	

For flexible cables

- HUBER+SUHNER full crimp



HUBER+SUHNER type	Item no.	Cable group (example)	Packaging	Assembly instruction	Crimp insert
11_QMA-50-2-1/133_NE 11_QMA-50-2-1/133_NH	23017700 23017701	U4 (K_02252_D, ENVIROFLEX_316_D)	single bulk 100 pcs.	27427	1 A
11_QMA-50-2-2/133_NE 11_QMA-50-2-2/133_NH	23017720 23017721	U2 (RG_316_/U, ENVIROFLEX_316)	single bulk 100 pcs.		

Series QMA – cable connectors

Straight cable plugs (male)

For flexible cables

- Cable entry crimp
- Centre contact plugged or soldered

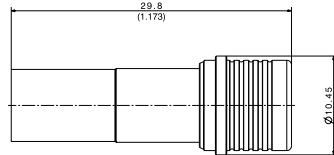
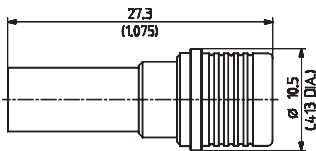

Fig. 1

Fig. 2

HUBER+SUHNER type	Item no.	Cable group (example)	Packaging	Assembly instruction	Crimp insert	Fig.
11_QMA-50-3-1/133_NE 11_QMA-50-3-1/133_NH	23017697 23017698	U9, U11 (RG_400_/U, ENVIROFLEX_400)	single bulk 100 pcs.	27429	B	1
11_QMA-50-3-2/133_NE 11_QMA-50-3-2/133_NH	23017702 23017703	U7 (RG_58_C/U, ENVIROFLEX_B58)	single bulk 100 pcs.			
11_QMA-50-4-2/133_NH	84000234	S16, X9, X28 (SX_04172_B-60, SPUMA_240, SPUMA_240-FR-01)	bulk 100 pcs.	0000231592	C	2

For flexible cables

- Waterproof
- Cable entry crimp
- Centre contact plugged or soldered

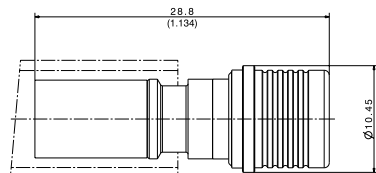
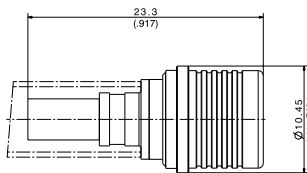

Fig. 1

Fig. 2

HUBER+SUHNER type	Item no.	Cable group (example)	Packaging	Assembly instruction	Crimp insert	Fig.
11_QMA-W50-2-8/133_NH	84104479	U2 (RG_316_/U, ENVIROFLEX_316)	bulk 100 pcs.	0000312675	A	1
11_QMA-W50-4-3/133_NE 11_QMA-W50-4-3/133_NH	84075865 84023153	S16, X9, X28, X34 (SX_04172_B-60, SPUMA_240, SPUMA_240-FR-01, SPUMA_240-RS-FR)	single bulk 100 pcs.	0000239799	C	2

Series QMA – cable connectors

Right angle cable plugs (male)

For semi-rigid, Sucoform and Multiflex cables

- Cable entry soldered
- Centre contact soldered

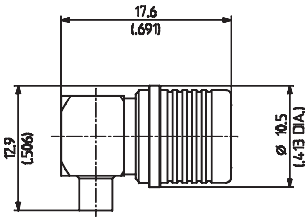

HUBER+SUHNER type	Item no.	Cable group (example)	Packaging	Assembly instruction
16_QMA-50-2-3/133_NE	23017666	Y3, Y11, Y16	single	27444
16_QMA-50-2-3/133_NH	23017667	{SUCOFORM_86, EZ_86}	bulk 100 pcs.	

For semi-rigid, Sucoform and Multiflex cables

- Cable entry soldered
- Centre contact soldered

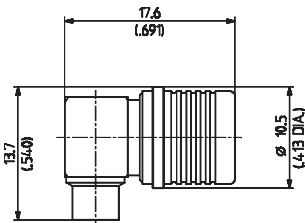

HUBER+SUHNER type	Item no.	Cable group (example)	Packaging	Assembly instruction
16_QMA-50-3-3/133_NE	23017693	Y5, Y12, Y17	single	27444
16_QMA-50-3-3/133_NH	23017694	{SUCOFORM_141, EZ_141}	bulk 100 pcs.	

Series QMA – cable connectors

Right angle cable plugs (male)

For semi-rigid, Sucoform and Multiflex cables

- Waterproof
- Cable entry soldered
- Centre contact soldered

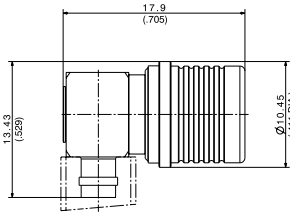

Fig. 1

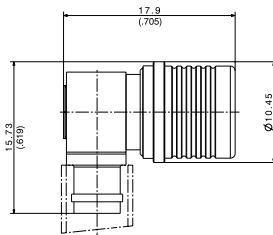
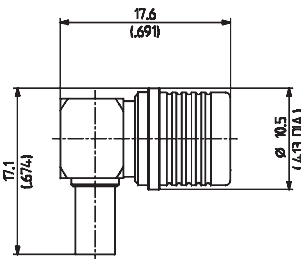

Fig. 2

HUBER+SUHNER type	Item no.	Cable group (example)	Packaging	Assembly instruction	Fig.	Notes
16_QMA-W50-2-9/113_NE 16_QMA-W50-2-9/113_NH	84068219 84075867	Y3, Y11, Y16 (SUCOFORM_86)	single bulk 100 pcs.	0000263789	1	body: SUCOPRO® gold plating
16_QMA-W50-3-5/113_NE	84075863	Y5, Y12, Y17 (SUCOFORM_141)	single	0000263850	2	body: SUCOPRO® gold plating

For flexible cables

- Cable entry crimp
- Centre contact soldered



HUBER+SUHNER type	Item no.	Cable group (example)	Packaging	Assembly instruction	Crimp insert
16_QMA-50-2-1/133_NE 16_QMA-50-2-1/133_NH	23017654 23017644	U4 (K_02252_D, ENVIROFLEX_316_D)	single bulk 100 pcs.	27443	A
16_QMA-50-2-2/133_NE 16_QMA-50-2-2/133_NH	23017657 23017658	U2 (RG_316_/U, ENVIROFLEX_316)	single bulk 100 pcs.		

Series QMA – cable connectors

Right angle cable plugs (male)

For flexible cables

- Cable entry crimp
- Centre contact soldered

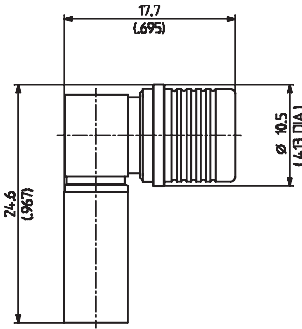

HUBER+SUHNER type	Item no.	Cable group (example)	Packaging	Assembly instruction	Crimp insert
16_QMA-50-3-1/133_NE 16_QMA-50-3-1/133_NH	23017686 23017687	U9, U11, U39 (RG_400_/U, ENVIROFLEX_400)	single bulk 100 pcs.	27443	B
16_QMA-50-3-2/133_NE 16_QMA-50-3-2/133_NH	23017691 23017692	U7 (RG_58_C/U, ENVIROFLEX_B58)	single bulk 100 pcs.		

For flexible cables

- Cable entry crimp
- Centre contact soldered

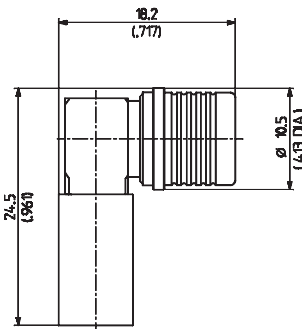

HUBER+SUHNER type	Item no.	Cable group (example)	Packaging	Assembly instruction	Crimp insert
16_QMA-50-4-1/133_NH	23012849	S16 (SX_04172_B-60)	bulk 100 pcs.	27405	C

Series QMA – cable connectors

Right angle cable plugs (male)

For flexible cables

- Waterproof
- Cable entry crimp
- Centre contact soldered

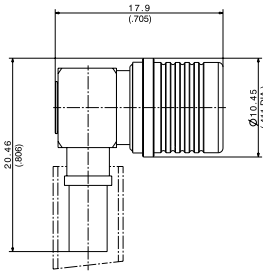

Fig. 1

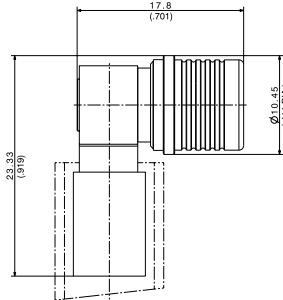

Fig. 2



HUBER+SUHNER type	Item no.	Cable group (example)	Packaging	Assembly instruction	Crimp insert	Fig.
16_QMA-W50-2-10/133_NH	84104679	U2 (RG_316_/U, ENVIROFLEX_316)	bulk 100 pcs.	0000312747	A	1
16_QMA-W50-4-5/133_NE 16_QMA-W50-4-5/133_NH	84075864 84023140	X9, X28, X34 (SX_04172_B-60, SPUMA_240, SPUMA_240-FR-01, SPUMA_240-RS-FR)	single bulk 100 pcs.	0000241978	C	2

Straight bulkhead cable jacks (female)

For semi-rigid, Sucoform and Multiflex cables

- Cable entry soldered
- Centre contact plugged-in

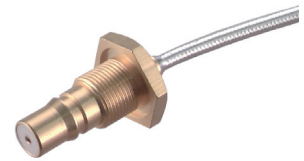
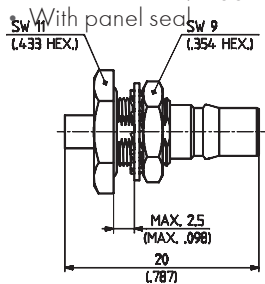

HUBER+SUHNER type	Item no.	Cable group (example)	Packaging	Assembly instruction	Mounting hole
24_QMA-50-2-1/111_NE 24_QMA-50-2-1/111_NH	23017742 23017743	Y3, Y11, Y16 (SUCOFORM_86, EZ_86)	single bulk 100 pcs.	27428	ML 20

Series QMA – cable connectors

Straight bulkhead cable jacks (female)

For semi-rigid, Sucoform and Multiflex cables

- Cable entry soldered
- Centre contact plugged-in
- With panel seal

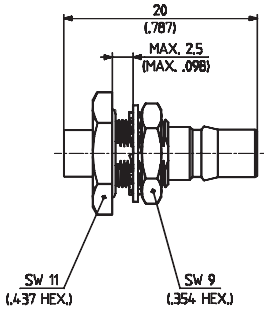

HUBER+SUHNER type	Item no.	Cable group (example)	Packaging	Assembly instruction	Mounting hole
24_QMA-50-3-3/111_NE	23017683	Y5, Y12, Y17	single	27428	ML 20
24_QMA-50-3-3/111_NH	23017684	(SUCOFORM_141, EZ_141)	bulk 100 pcs.		

For flexible cables

- Cable entry crimp
- Centre contact soldered
- With panel seal

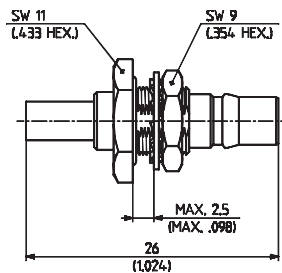

HUBER+SUHNER type	Item no.	Cable group (example)	Packaging	Assembly instruction	Mounting hole	Crimp insert
24_QMA-50-2-2/133_NE	23017829	U4 (K_02252_D,	single	27429	ML 20	A
24_QMA-50-2-2/133_NH	23017830	ENVIROFLEX_316_D)	bulk 100 pcs.			
24_QMA-50-2-3/133_NE	23017837	U2 (RG_316_/U,	single			
24_QMA-50-2-3/133_NH	23017838	ENVIROFLEX_316)	bulk 100 pcs.			

Series QMA – cable connectors

Straight bulkhead cable jacks (female)

For flexible cables

- Cable entry crimp
- Centre contact soldered
- With panel seal

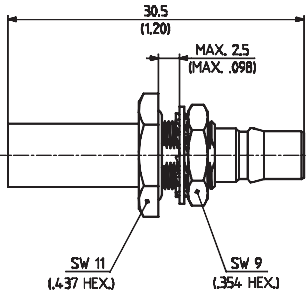

HUBER+SUHNER type	Item no.	Cable group (example)	Packaging	Assembly instruction	Mounting hole	Crimp insert
24_QMA-50-3-1/133_NE	23017822	U9, 11 (RG_400_/U,	single	27429	ML 20	B
24_QMA-50-3-1/133_NH	23017823	ENVIROFLEX_400)	bulk 100 pcs.			
24_QMA-50-3-2/133_NE	23017795	U7 (RG_58_C/U,	single			
24_QMA-50-3-2/133_NH	23017796	ENVIROFLEX_B58)	bulk 100 pcs.			

Series QMA – receptacles

Straight bulkhead receptacles, jacks (female)

- Coaxial end
- Press-in chassis mount

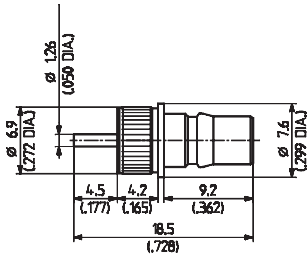

HUBER+SUHNER type	Item no.	Packaging	Mounting hole	Notes
22_QMA-50-0-7/133_NF	84001926	bulk 50 pcs.	ML 143	press-in

- Coaxial end
- Screw-in chassis mount

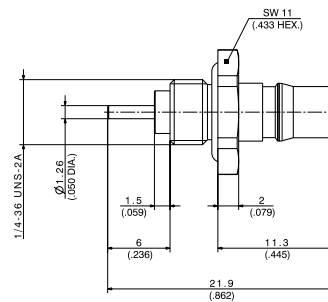
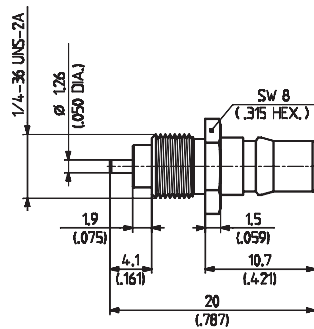

Fig. 1

Fig. 2

HUBER+SUHNER type	Item no.	Packaging	Fig.	Notes
22_QMA-50-0-4/133_NH	23022628	bulk 100 pcs.	1	extended dielectric, without panel seal
22_QMA-50-0-34/133_NH	84061333		2	extended dielectric, with panel seal

Series QMA – receptacles

Straight panel receptacle, jack (female)

- 2-hole flange
- Without panel seal
- With coaxial end

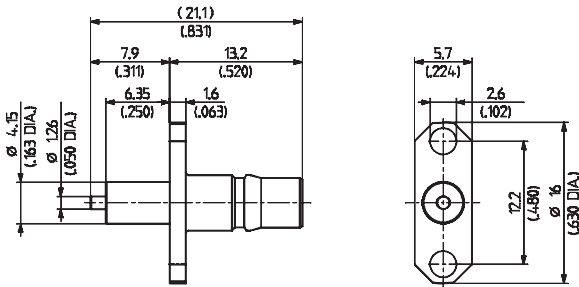

HUBER+SUHNER type	Item no.	Packaging	Notes
23_QMA-50-0-2/111_NH	23024985	bulk 100 pcs.	extended dielectric

- 4-hole flange
- Without panel seal
- With coaxial end

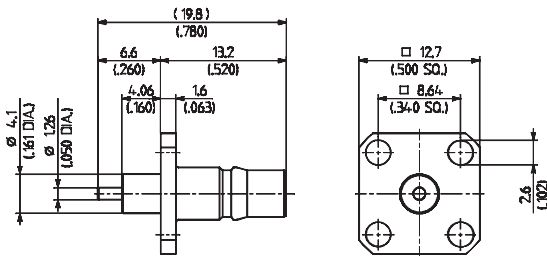

HUBER+SUHNER type	Item no.	Packaging	Notes
23_QMA-50-0-3/111_NH	23025007	bulk 100 pcs.	extended dielectric

Series QMA – PCB connectors

Straight PCB jacks (female)

- With stand-off

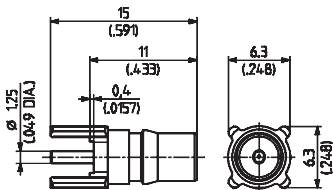

HUBER+SUHNER type	Item no.	Packaging	PCB layout
82_QMA-50-0-3/111_NH	23017656	bulk 100 pcs.	ML 41

- Surface mount type SMT

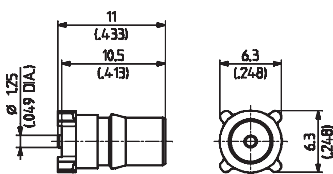

HUBER+SUHNER type	Item no.	Packaging	PCB layout
82_QMA-S50-0-2/111_NH	23017631	bulk 100 pcs.	ML 136

- With ground pins through-hole and SMT signal pin

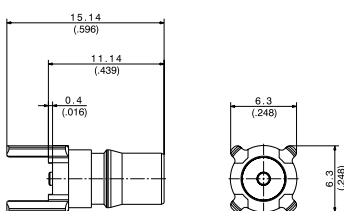

HUBER+SUHNER type	Item no.	Packaging	PCB layout
96_QMA-50-0-1/111_NH	84003328	bulk 100 pcs.	ML 155

Series QMA - PCB connectors

Right angle PCB jacks (female)

- Surface mount type SMT (with positioning pin)

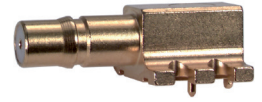
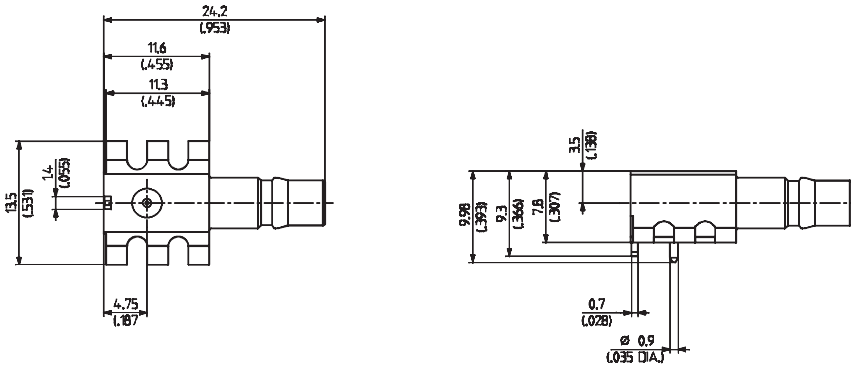

HUBER+SUHNER type	Item no.	Packaging	PCB layout
85_QMA-S50-0-2/111_NM	23021299	tape and reel	ML 137

- With stand-off

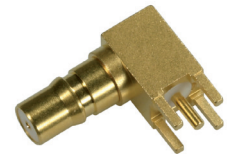
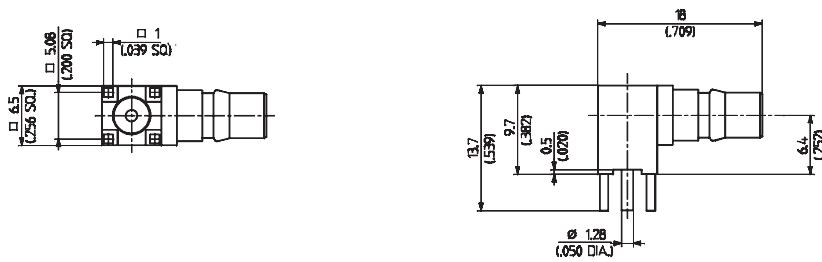

HUBER+SUHNER type	Item no.	Packaging	PCB layout
85_QMA-50-0-3/111_NH	23021463	bulk 100 pcs.	ML 41

- Surface mount type SMT
- Bulkhead mounted

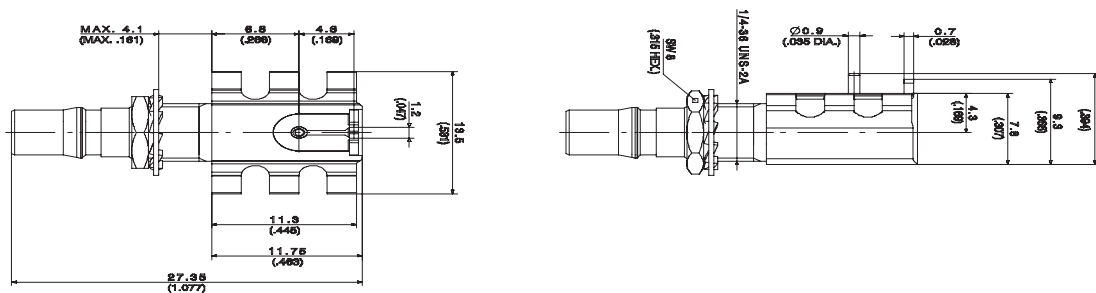

HUBER+SUHNER type	Item no.	Packaging	PCB layout
85_QMA-S50-0-5/111_NH	23037099	bulk 100 pcs.	ML 137

Cable groups see page 32 Assembly tools see page 531 Mounting holes/PCB layouts see page 561